

YUASA  **BATTERY**

2023



Powersports Battery
Applications & Specifications

CONTENTS

Battery Information

About Yuasa Battery	1
Features and Benefits	3
Featured Products	4
Terminal Types	8
Hardware / Battery Type Numbers	9

Battery Specifications

AGM, High Performance Batteries	10
AGM Batteries	11
High Performance, Conventional Batteries	13
Conventional Batteries	15
Tractor Battery Specifications	16
Battery Cross Reference	17

Applications

Motorcycle	18
Utility Vehicle (UTV)	28
Scooter	29
All Terrain Vehicle (ATV)	30
Personal Watercraft (PWC)	33
Snowmobile	34

Chargers, Accessories & Merchandise

Consumer Products	37
Digital Print Tester	38
Merchandising Products	39
Technical Manual	41

DISCLAIMER

The replacement battery information published in this book has been obtained from the equipment manufacturers listed, except as otherwise noted. Users are cautioned that the information contained in this book was the most current information provided to us at the time of publication. The information is subject to change upon notice from equipment manufacturers or field experience. Users should always use the most current edition of the Yuasa Battery Applications and Specifications. Yuasa expressly denies any responsibility for the accuracy of the information provided to us. While we have made every effort to accurately catalog the replacement battery information contained in this book, Yuasa denies any liability for damages as a consequence of using the information in this book. Users should also attempt to obtain replacement battery information from the equipment manufacturer's user manual or service department for their specific application.

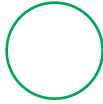

GYZ Series AGM

- More active material surface area for enhanced performance and power
- Highest CCA motorcycle battery (500 CCA on GYZ32HL)
- Large heavy-duty flush terminals with multiple connections (GYZ32HL, GYZ20HL, GYZ20H)
- Built in brass nuts (GYZ32HL, GYZ20H, GYZ20HL)



High Performance AGM

- All the features of a standard AGM battery plus increased power
- YTZ Series: Small size, lightweight with huge power.
- H Series: Increased power-up to 30% more cold cranking amps
- YIX Series: Improves cold climate performance



AGM (Maintenance Free)

- Maintenance Free – no need to add water, but periodic charging required when not in use
- Absorbed Glass Mat (AGM) Separators – an advanced battery technology that eliminates the need to ever add water
- Advanced lead-calcium technology – holds its specific gravity more than 3 times longer than conventional lead antimony batteries



Yumicron / Conventional

- Special thin separators – allow two extra plates per cell to be installed, for a 30% improvement in cranking performance
- Engineered to protect against corrosion, withstand vibration, and deliver high cranking power
- The original batteries with thicker plates and separators.
- 6 volt and 12 volt varieties

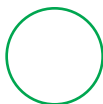

ABOUT YUASA BATTERY

YUASA BATTERY THE PIONEER AND LEADER OF POWERSPORTS BATTERIES SINCE 1979

THE INDUSTRY STANDARD

Yuasa has set the standard by which all other powersports batteries are judged. It's why **more OEMs** and riders - in the US and worldwide - choose Yuasa.

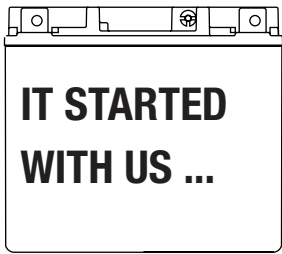
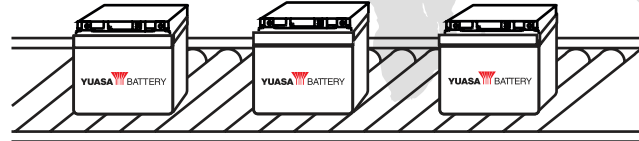

1981 • 1st OEM motorcycle battery YB14L-A2 to Honda

1985 • 1st OEM ATV battery YB14A-A2 to Polaris
• 1st OEM snowmobile battery YB16L-B to Arctic Cat

1979 • 1st Conventional Battery: 12N14-3A
• 1st Yumicron Battery: YB14L-A2

1983 • World's 1st maintenance-free AGM motorcycle battery: **YT Series**

1987 • 1st OEM personal water craft battery, YB16CL-B to Kawasaki

2008 • The most powerful, toughest AGM batteries for the American market: **GYZ Series**
• 1st OEM motorcycle battery GYZ20L for Honda Goldwing

2017 • **100th anniversary of Yuasa's parent company, GS Yuasa.**
"100 Years of History, 200 Years of Expertise"

2004 • 1st OEM motorcycle battery YTX20CH-BS to Suzuki

2011 • 1st OEM battery GYZ16H to Honda





Yuasa Battery Plant Facility

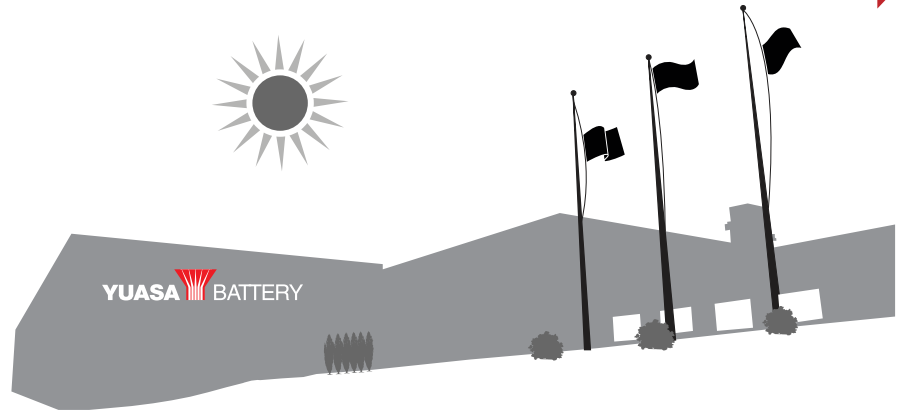
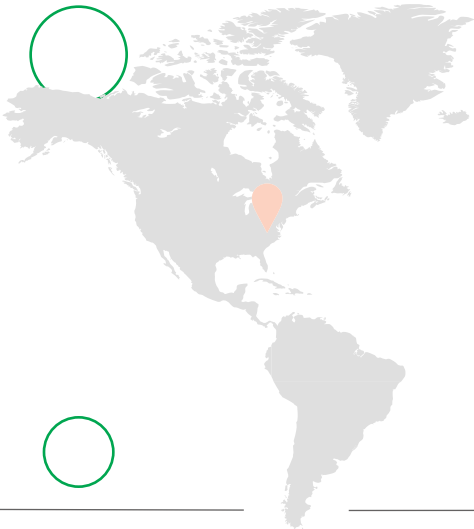

1988

- 1st OEM WaveRunner battery to Yamaha YB16CL-B
- Industry's de-facto standard for AGM motorcycle batteries even today: **YTX series**

1990

- 1st YTX OEM ATV battery YTX12-BS to Honda

2001

- 1st OEM SEA-DOO to BRP YB30CL-B

1989

- 1st YTX battery: YTX12BS

1999

- The most powerful, compact AGM batteries for powersports applications: **YTZ series** (1st FA global lineup)

**ADVANCED ENGINEERING,
PREMIUM QUALITY,
UNMATCHED RELIABILITY**

2022



- Launch of the YBX series in the North American market.

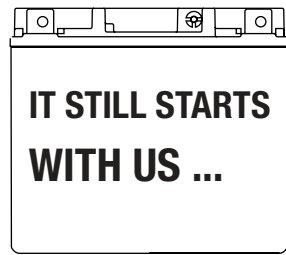

OUR PRODUCTS AND SERVICES ARE REFLECTIONS OF WHO WE ARE.









EACH AND EVERY DAY,

It *starts* with us

FEATURES AND BENEFITS

Components	Features	Benefits
Cast grid	Special grid design	Severe vibration resistance and improved conductivity
Active material	Proprietary formulation	Reduced shedding, maximum utilization and long service life
Pasted plates	Specified thickness and weight	Ensures vibration resistance through precise compression and proper service life through specified active material balance
Dried-charged plates	Tank formed and dried plates	Properly dried plates in a sealed battery have a virtually limitless shelf-life
Top lead connections	Through-partition construction, large straps	Shorter current path for increased electrical conductivity and higher starting currents, heavier parts for maximum durability
Case-cover seal	Thermal bonded plastic	Air tight seal to prevent air ingress and acid seepage
Terminal-cover seal	Patented poly-seal terminal	Eliminates acid seepage, reduces corrosion and extends battery life
Case and cover	Polypropylene	Superior resistance to gasoline and oil, impact resistant in extreme weather conditions
Additive	Sulfate stop (some models)	Sulfate stop added to reduce the solubility of lead into the acid, which then reduces battery sulfation potential
Yumicron		
Separator	Leaf or envelope separator	Polyethylene with glass mat sheet bonded for compression to withstand severe vibration conditions
GYZ/YTX/High Performance AGM		
Separator	AGM (absorbed glass mat)	High puncture resistant separator for increased service in high vibration applications
Top lead alloy	Calcium alloy	Increased weld strength and severe vibration resistance
Vent system	Valve and flame arrestor	Valve relieves excess pressure to prevent bursting, flame arrestor prevents internal combustion



GYZ	CAPACITY [AH]	CCA*	V-TWIN	ATV/UTV	UPGRADE FOR:	CAPACITY [AH]	CCA*
GYZ16H	16	240			YTX14	12	200
GYZ16HL**	16	240			YTX14L	12	200
GYZ20H	20	320			YTX20H	18	310
GYZ20HL	20	320			YTX20HL	18	310
GYZ32HL	32	500			YIX30L	30	400

*CCA measured by BC/SAE standard at 0° F.
 **Upgraded to built in brass nuts

GYZ CUTAWAY DIAGRAM

EZ Grip Cover:
 simple installation
 (GYZ32HL)

Large heavy-duty flush terminals:
 constructed to allow multiple front and top connections, mounting position flexibility

Built-in brass nuts:
 up to 50% more conductive than stainless steel
 (GYZ32HL, GYZ20HL, GYZ20H, GYZ16HL)

Enhanced active material:
 compounded to withstand vibration, prolong battery life and dependability

Absorbed Glass Mat (AGM) separators:
 absorb electrolyte, making the battery nonspillable

Protective separator material:
 enhances vibration resistance

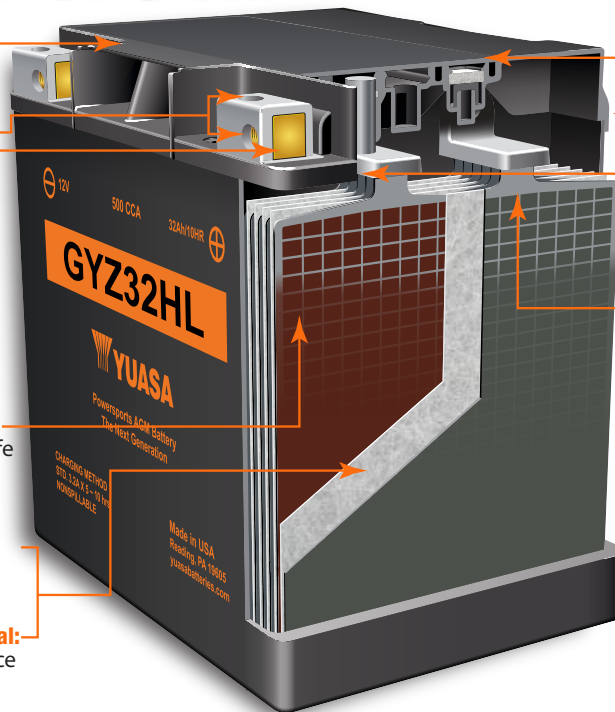





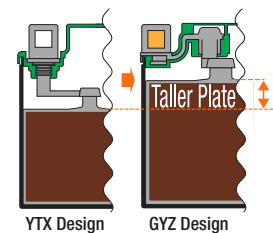

Safety flame-arrestor:
 leakproof valve relieves excess pressure

Heat bonded cover:
 eliminates leaks and corrosion

Thru-partition construction:
 provides shorter current path with less resistance than "over the partition" construction, resulting in more cranking power

Taller plates:
 extra surface area for more power: up to 500 CCA and 32 Ah to power more accessories



GYZ	CAPACITY [AH]	CCA*	METRIC	ATV/UTV	UPGRADE FOR:	CAPACITY [AH]	CCA*
GYZ16H	16	240			YTX14	12	200
GYZ20L	20	250			YTX20L	18	270
GYZ20H-A	20	320			N/A	N/A	N/A

YTZ BATTERY

YTZ	CAPACITY Ah (10HR)	CAPACITY Ah (20HR)	CCA*	Dimensions - Inches LxWxH (±1/16 in)	Dimensions - Millimeters LxWxH (±2 mm)	Approx. Weight with Acid (LBS)	Approx. Weight with Acid (KGS)
YTZ7S	6	6.3	130	4 7/16 x 2 3/4 x 4 1/8	113 x 70 x 105	4.6	2.1
YTZ10S	8.6	9.1	190	6 x 3 7/16 x 3 11/16	150 x 87 x 93	7.0	3.2
YTZ12S	11	11.6	210	6 x 3 7/16 x 4 3/8	150 x 87 x 110	8.2	3.7
YTZ14S	11.2	11.8	230	6 x 3 7/16 x 4 3/8	150 x 87 x 110	8.6	3.9

*CCA measured by BCI/SAE standard at 0° F.

YTZ CUTAWAY DIAGRAM

HEAT SEALED CASE TO COVER

Protects against leakage and corrosion and provides for extra strength and durability

SPECIAL ACTIVE MATERIAL

Compounded to withstand vibration, it prolongs the battery life in storage and provides reliable starting power when needed

UNIQUE EXPANDED PLATE GRID DESIGN

Increased number of plates for maximum starting power and to withstand severe vibration resistance

AGM SEPARATORS

Absorbed Glass Matt separators absorb the electrolyte and make the battery spill-proof. The valve regulated design eliminates water loss and the need for refilling

POLYPROPYLENE (PP) COVER & CONTAINER

Protects against fuel and oil and designed to withstand vibration and impact under extreme conditions

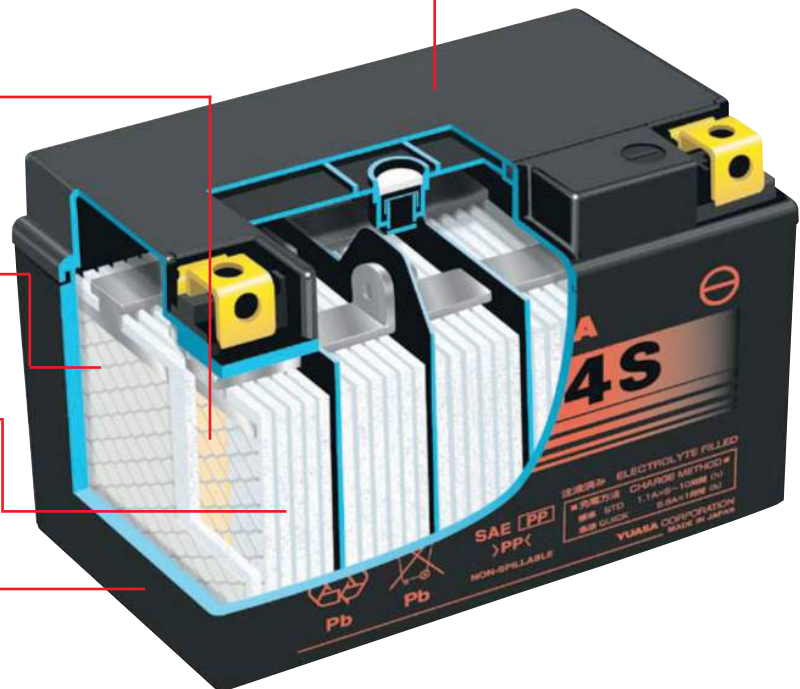

LONGER BATTERY LIFE WITH MORE VOLUME EFFICIENCY



YBX9140R
Group 140R
L1

YBX

9000

AGM

**START
STOP
PLUS**







Manufacturer	Part Number	CCA	Model	Year
KAWASAKI	YBXM79L1560MUL	990	MULE PRO DTX, DX	16-22
		950	KAF950 MULE 2510	-10
			MULE 4010 DIESEL	11-13
		820	MULE PRO, FXT, FX	15-22
POLARIS	YBXM79L1560RZR	1000	RZR, XP, TURBO 4	14-22
		900	TRAIL	21-22
	YBXM79L1560RAN	1000	GENERAL 4, XP, XP4	16-22
			RANGER DIESEL	15-18
			CREW 1000	17-22
			CREW XP	17-22
	YBXM79L1560RAN	900	RANGER DIESEL	11-14
			RANGER XP	13-22
			RANGER CREW	14-22
			800	RANGER 6x6
		570	RANGER 570, NSTR	-22

YUASA BATTERY

Yuasa Battery Technical Data Sheet

Yuasa YBX9140R - YBX9000 AGM Start Stop Batteries

Performance	
Voltage	12V
Capacity (20-hour)	50Ah
Cold Cranking Amps	560A

Performance Marking			
 <p>WATER LOSS W5 W1 - W5</p>	 <p>CHARGE RETENTION C2 C1 - C2</p>	 <p>VIBRATION V3 V1 - V4</p>	 <p>MICRO-CYCLE M3 M1 - M3</p>

Dimensions		
Length	8 1/2 in	207 mm
Width	6 7/8 in	175 mm
Height	7 1/2 in	190 mm



Weights & Measures		
Mean Weight with Acid	34.17 lbs	15.5 kg





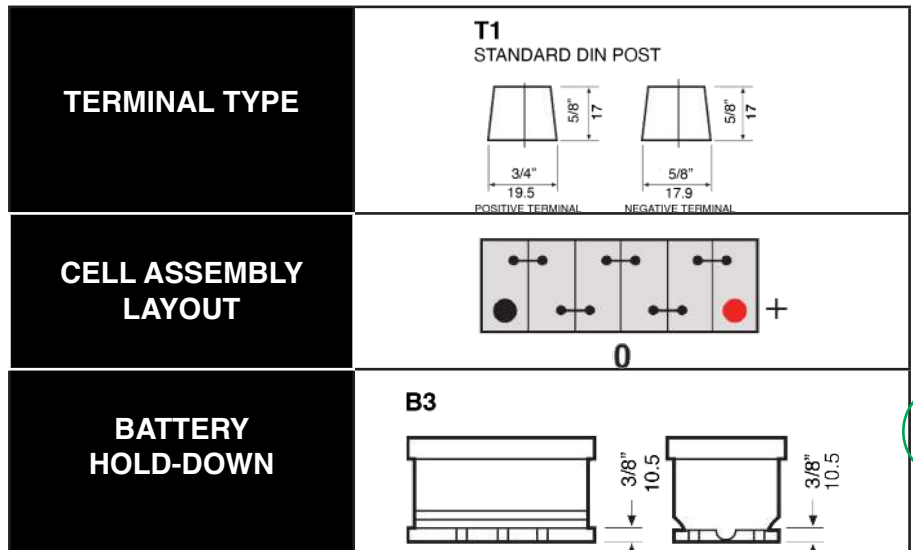



















































Container Features	
Case Type	L1 DIN AGM
Hold Down	B3
Handles	Yes
End Venting	Yes
Semi-Traction Features	Yes
Lid Type	VRLA

Technology	
Flame Arrestor	Yes
Technology	Ca/Ca VRLA
Separator	AGM
VDA Roll Over Test	Yes
Recommended Charge Rate	3A



TERMINAL TYPES

Terminal shapes vary from one battery to another. By identifying the correct replacement battery from the listing in this book, you are assured of the proper terminal configuration. For custom applications, refer to the following chart to identify terminal shape and corresponding batteries.

Type	Terminal				Battery Type				
	Illustration	Front	Side	Top					
1					YB7C-A	YTX16-BS-1	YB14L-A1		
2					YB9L-A2	12N5.5-4A	YB16AL-A2		
3					12N24-3	12N24-3A	Y60-N24-A		
4					GYZ20L YB30L-B YTX15L-BS YTX20L-BS	Y50-N18L-A3 YIX30L-BS YTX16-BS YTX24HL-BS	YB12C-A YIX30L-BS-PW YTX20-BS YTX20HL-BS	YB16B-A YTX14AHL-B YTX20H-BS YIX20HL-BS	YB30CL-B YTX14AH-BS YTX20HL-BS-PW GYZ20H-A
5					GYZ16H GYZ16HL YB4L-B YTX14L-BS	YTX7L-BS KMX14-BS YT12A-BS YTX20CH-BS	YTX9-BS YB16C-B YTX12-BS YTX4L-BS	YTZ5S YTZ7S YB16CL-B YTX14-BS	YTX5L-BS YB4L-A YTX14H-BS YTX7A-BS
6					YB3L-A YB7L-B YB12A-A YB16-B 12N5-3B 12N7-4A 12N9-4B-1 6N6-3B	YB3L-B YB9A-A YB12AL-A YB-16-B-CX 12N5-4B 12N7-4B 12N10-3A 6N6-3B-1	YB5L-B YB9-B YB12AL-A2* YB16L-B 12N5.5-3B 12N7-3B 6N11A-1B B54-6	YB7-A YB9L-B YB12A-B YB16HL-A-CX 12N5.5A-3B 12N12A-4A-1 6N11-2D B38-6A	YB7B-B YB10L-B YB14A-A1 SYB16L-B 12N7-3B 12N9-3B 6N12A-2D B39-6
7					HYB16A-AB Y50-N18A-A	YB16B-A1** Y50-N18L-A	YB18-A Y50-N18L-A-CX	YB18L-A SY50-N18L-AT	
8					YB10A-A2 YB14-A2 YB14L-B2	YB10L-A2 YB14A-A2 YB14L-B2	YB10L-B2 YB14L-A2 12N14-3A	YB12B-B2 SYB14L-A2 12N11-3A-1	
9					YHD-12				
10					51814	51913	53030	YT19BL-BS	
11					YT9B-BS YT7B-BS	YTZ10S YT12B-BS	YTZ12S	YTZ14S	YT14B-BS
12					YTR4A-BS				
13					YT4B-BS				
14					GYZ20H	GYZ32HL	GYZ20HL		
					Note: Encapsulated Brass Nut				

* Includes terminal adapter for converting to top mount
 ** Includes terminal adapter for converting to side mount

HARDWARE AND BATTERY TYPE NUMBERS

Part No.	Includes**	Fits				
478030	12mm lg. stainless steel hex bolt 20mm lg. stainless steel hex bolt 8mm stainless steel nut, lock washer and round brass spacer	YTX20-BS	YTX20L-BS	YB30CL-B	YB30L-B	
479100	12mm lg. stainless steel hex bolt 5mm stainless steel rectangular nut	Y50-N18L-A3 YTX14H-BS	YTX9-BS YTX14AH-BS	YTX12-BS YTX14AHL-BS	YTX14-BS GYZ16H	YTX20CH YIX30L
479862	12mm lg. stainless steel hex bolt 8mm stainless steel rectangular nut	YTX15L-BS YTX24HL-BS	YTX20(H)-BS YIX20HL-BS	YIX30L-BS-PW YB30L-B	GYZ20L YB30CL-B	
479102	14mm lg. stainless steel hex bolt 5mm stainless steel square nut	YB16CL-B YTX14L	YB16C-B Y50-N18L-A-CX	Y50-N18L-A HYB16A-AB	YB18-A	
479104	12mm lg. stainless steel hex bolt 20mm lg. stainless steel hex bolt 5mm stainless steel nut, lock washer and round brass spacer	YTX14L-BS for Harley Davidson Sportster YTX14 ^{FA} for Harley Davidson V-ROD 02-07 YTX14H ^{FA} for Harley Davidson V-ROD 02-07 YTX12 YIX30L				
479643	12mm lg. stainless steel hex bolt 20mm lg. stainless steel hex bolt 8mm brass nut, lock washer and square brass spacer	YTX20H-BS YTX20(H)L-BS-PW	YTX20HL-BS	YTX24HL-BS	YIX30L-BS	
479876	12mm lg. stainless steel hex bolt 16mm lg. stainless steel hex bolt 5mm rectangular brass nut, lock washer and square brass spacer	YIX30L				
479699	12mm lg. stainless steel hex bolt and lock washer	GYZ20H	GYZ20HL	GYZ32HL		
4710123	12mm lg stainless steel hex bolt lock washer square brass spacer	GYZ16HL				
5BNBSBA12	12mm lg. brass hex bolt 5mm brass nut	GYZ20H-A				
5BNBSSF6M	11mm lg. stainless steel hex bolt 5mm stainless steel hex nut	YB14A-A1 YB14L-A2	YB14L-B2 YB14-A2	YB14A-A2 YB14-B2		
5BNBSS14M	14mm lg. stainless steel hex bolt 5mm stainless steel hex nut	12N74A YB18L-A	HYB16A-AB YHD-12H	YB16L-B Y50-N18L-A	YB18-A SY50-N18L-A	
5BNBSS22M	22mm lg. stainless steel hex bolt 5mm stainless steel hex nut and round brass spacer	YB16-B	YB16-B-CX	YB16HL-A-CX	YB16L-B	

DESIGNATION OF BATTERY TYPE NUMBERS

Conventional

12 N 12A-4 A-1

1 2 3 4 5 6

- 1 Nominal voltage
- 2 Conventional battery
- 3 Size of battery case
- 4 Polarity location
- 5 Exhaust location
- 6 Designates unique terminal

High Performance Conventional

YB 16A L-A2

1 2 3 4

- 1 High Performance Conventional battery
- 2 Size of battery case
- 3 Polarity location
- 4 Terminal and Exhaust location

AGM

YTX 14 A H L-BS-1

1 2 3 4 5 6 7

- 1 High Performance AGM (YTX, YIX, YTZ, YT, GYZ)
- 2 Performance classification
- 3 Designates unique battery case size
- 4 Higher CCA
- 5 Polarity location
- 6 Bottle supplied electrolyte
- 7 Designates unique terminal

** All hardware listed above is M6 thread
^{FA} Must use factory activated battery

BATTERY SPECIFICATIONS

AGM, HIGH PERFORMANCE

FACTORY ACTIVATED (Non-Spillable)

12 VOLT

Battery Type	Capacity Ah (10-HR)	Dimensions – Inches (± 1/16 in)			Dimensions – Millimeters (± 2 mm)			Assembly Figure (As Per Cover Polarity)	Approx Weight with Acid (lbs.)	Terminal Type (Refer to page 8)	Acid Volume (Liter)	Regular Charge Current (Amp)	C.C.A. @ 0 °F (-18 °C)
		L	W	H	L	W	H						
GYZ16H	16	6	3 7/16	5 3/4	150	87	145	⊖ ⊕	12.4	5	N/A	1.6	240
GYZ16HL	16	6	3 7/16	5 3/4	150	87	145	⊖ ⊕	12.4	5	N/A	1.6	240
GYZ20L	20	6 7/8	3 7/16	6 1/8	175	87	155	⊖ ⊕	15.2	4	N/A	2.0	250
GYZ20H	20	6 7/8	3 7/16	6 1/8	175	87	155	⊕ ⊖	15.7	14	N/A	2.0	320
GYZ20H-A	20	6 7/8	3 7/16	6 1/8	175	87	155	⊕ ⊖	15.7	14	N/A	2.0	320
GYZ20HL	20	6 7/8	3 7/16	6 1/8	175	87	155	⊖ ⊕	15.7	14	N/A	2.0	320
GYZ32HL	32	6 9/16	5	6 7/8	166	126	175	⊖ ⊕	24.7	14	N/A	3.2	500
YTX14AH *	12	5 5/16	3 1/2	6 9/16	134	89	166	⊕ ⊖	11.1	4	N/A	1.2	210
YTX14AHL	12	5 5/16	3 1/2	6 9/16	134	89	166	⊖ ⊕	11.1	4	N/A	1.2	210
YTX14H	12	6	3 7/16	5 3/4	150	87	145	⊕ ⊖	10.6	5	N/A	1.2	240
YTX20CH	18	6	3 7/16	6 3/8	150	87	161	⊕ ⊖	13.4	5	N/A	1.8	270
YTX20H	18	6 7/8	3 7/16	6 1/8	175	87	155	⊕ ⊖	15.1	4	N/A	1.8	310
YTX20HL	18	6 7/8	3 7/16	6 1/8	175	87	155	⊖ ⊕	15.1	4	N/A	1.8	310
YIX20HL	18	6 7/8	3 7/16	6 1/8	175	87	155	⊖ ⊕	15.1	4	N/A	1.8	320
YTX20HL-PW **	18	6 7/8	3 7/16	6 7/8 ^S	175	87	175 ^S	⊖ ⊕	15.1	4	N/A	1.8	310
YTX24HL	21	8 1/8	3 7/16	6 3/8	205	87	162	⊖ ⊕	17.5	4	N/A	2.1	350
YIX30L	30	6 9/16	5	6 7/8	166	126	175	⊖ ⊕	22.0	4	N/A	3.0	400
YIX30L-PW ***	30	6 9/16	5	7 9/16 ^S	166	126	192 ^S	⊖ ⊕	22.0	4	N/A	3.0	400
YTZ7S	6	4 7/16	2 3/4	4 1/8	113	70	105	⊖ ⊕	4.6	5	N/A	0.6	130
YTZ8V	7	4 7/16	2 3/4	5 1/8	113	70	130	⊖ ⊕	6.0	5	N/A	0.7	120
YTZ10S	8.6	6	3 7/16	3 11/16	150	87	93	⊕ ⊖	7.0	11	N/A	0.9	190
YTZ12S	11	6	3 7/16	4 3/8	150	87	110	⊕ ⊖	8.1	11	N/A	1.1	210
YTZ14S	11.2	6	3 7/16	4 3/8	150	87	110	⊕ ⊖	8.6	11	N/A	1.1	230

* Includes 10mm height spacer for use in replacing YB14A-A1 and YB14A-A2
 ** Includes 20mm height spacer (S) for use in replacing YB16CL-B
 *** Includes 17mm height spacer for use in replacing YB30CL-B
 (S) Includes spacer

BATTERY SPECIFICATIONS

AGM, HIGH PERFORMANCE

FRESH PACK (Battery Supplied Dry with an Acid Bottle)

12 VOLT

Battery Type	Capacity Ah (10-HR)	Dimensions – Inches (± 1/16 in)			Dimensions – Millimeters (± 2 mm)			Assembly Figure (As Per Cover Polarity)	Approx Weight with Acid (lbs.)	Terminal Type (Refer to page 10)	Acid Volume (Liter)	Regular Charge Current (Amp)	C.C.A. @ 0 °F (-18 °C)
		L	W	H	L	W	H						
YTZ5S-BS	3.5	4 7/16	2 3/4	3 3/8	113	70	86		3.5	5	0.20	0.4	65
YTX14AH-BS *	12	5 5/16	3 1/2	6 9/16	134	89	166		11.1	4	0.66	1.2	210
YTX14AHL-BS	12	5 5/16	3 1/2	6 9/16	134	89	166		11.1	4	0.66	1.2	210
YTX14H-BS	12	6	3 7/16	5 3/4	150	87	145		10.6	5	0.69	1.4	240
YTX20CH-BS	18	6	3 7/16	6 3/8	150	87	161		13.4	5	0.82	1.8	270
YTX20H-BS	18	6 7/8	3 7/16	6 1/8	175	87	155		15.1	4	0.93	1.8	310
YTX20HL-BS	18	6 7/8	3 7/16	6 1/8	175	87	155		15.1	4	0.93	1.8	310
YTX20HL-BS-PW **	18	6 7/8	3 7/16	6 7/8 ^s	175	87	175 ^s		15.1	4	0.93	1.8	310
YIX20HL-BS	18	6 7/8	3 7/16	6 1/8	175	87	175		15.1	4	0.93	1.8	320
YTX24HL-BS	21	8 1/8	3 7/16	6 3/8	205	87	162		17.5	4	1.08	2.1	350
YIX30L-BS	30	6 9/16	5	6 7/8	166	126	175		22.0	4	1.4	3.0	400
YIX30L-BS-PW ***	30	6 9/16	5	7 9/16 ^s	166	126	192 ^s		22.0	4	1.4	3.0	400

- * Includes 10mm height spacer for use in replacing YB14A-A1 and YB14A-A2
- ** Includes 20mm height spacer (°) for use in replacing YB16CL-B
- *** Includes 17mm height spacer for use in replacing YB30CL-B
- (°) Includes spacer

AGM

FACTORY ACTIVATED (Non-Spillable)

12 VOLT

Battery Type	Capacity Ah (10-HR)	Dimensions – Inches (± 1/16 in)			Dimensions – Millimeters (± 2 mm)			Assembly Figure (As Per Cover Polarity)	Approx Weight with Acid (lbs.)	Terminal Type (Refer to page 10)	Acid Volume (Liter)	Regular Charge Current (Amp)	C.C.A. @ 0 °F (-18 °C)
		L	W	H	L	W	H						
YTX9	8	6	3 7/16	4 3/16	150	87	105		6.6	5	N/A	0.9	135
YTX12	10	6	3 7/16	5 1/8	150	87	130		9.2	5	N/A	1.2	180
YT12B	10	6	2 3/4	5 1/8	150	69	130		9.2	5	N/A	1.2	210
YTX14	12	6	3 7/16	5 3/4	150	87	145		10.1	5	N/A	1.4	200
YTX14L	12	6	3 7/16	5 3/4	150	87	145		10.1	5	N/A	1.4	200
YTX15L	13	6 7/8	3 7/16	5 1/8	175	87	130		11.0	4	N/A	1.3	230
YTX20	18	6 7/8	3 7/16	6 1/8	175	87	155		13.9	4	N/A	1.8	270
YTX20L	18	6 7/8	3 7/16	6 1/8	175	87	155		13.9	4	N/A	1.8	270
Battery Type	Capacity Ah (20-HR)	Dimensions – Inches (± 1/16 in)			Dimensions – Millimeters (± 2 mm)			Assembly Figure (As Per Cover Polarity)	Approx Weight with Acid (lbs.)	Terminal Type (Refer to page 7)	Acid Volume (Liter)	Regular Charge Current (Amp)	C.C.A. @ 0 °F (-18 °C)
		L	W	H	L	W	H						
YBX9140R	50	8 1/2	6 7/8	7 1/2	207	175	190		37.17	T1	N/A	3	560

FRESH PACK (Battery Supplied Dry with an Acid Bottle)

12 VOLT

Battery Type	Capacity Ah (10-HR)	Dimensions – Inches (± 1/16 in)			Dimensions – Millimeters (± 2 mm)			Assembly Figure (As Per Cover Polarity)	Approx Weight with Acid (lbs.)	Terminal Type (Refer to page 10)	Acid Volume (Liter)	Regular Charge Current (Amp)	C.C.A. @ 0 °F (-18 °C)
		L	W	H	L	W	H						
YTR4A-BS	2.3	4 1/2	1 15/16	3 3/8	114	49	86		2.4	12	0.14	0.3	45
YT4B-BS	2.3	4 1/2	1 9/16	3 7/16	114	39	86.5		2.4	13	0.12	0.3	40
YTX4L-BS	3	4 1/2	2 13/16	3 3/8	114	71	86		3.4	5	0.18	0.4	50
YTX5L-BS	4	4 1/2	2 13/16	4 3/16	114	71	106		4.2	5	0.24	0.5	80
YT7B-BS	6.5	6	2 9/16	3 11/16	150	65	93		5.9	11	0.33	0.7	110
YTX7A-BS	6	6	3 7/16	3 3/4	150	87	94		6.3	5	0.33	0.7	105
YTX7L-BS	6	4 1/2	2 13/16	5 3/16	114	71	131		6.1	5	0.33	0.6	100
YT9B-BS	8	6	2 3/4	4 1/8	150	70	105		8.7	11	0.40	0.8	120
YTX9-BS	8	6	3 7/16	4 3/16	150	87	105		6.6	5	0.40	0.9	135
YT12A-BS	10	6	3 7/16	4 3/16	150	87	105		7.7	5	0.47	1.0	175
YT12B-BS	10	6	2 3/4	5 1/8	150	69	130		9.0	11	0.52	1.0	210
YTX12-BS	10	6	3 7/16	5 1/8	150	87	130		9.2	5	0.60	1.2	180
KMX14-BS ^K	12	6	3 7/16	5 3/4	150	87	145		10.1	5	0.69	1.4	200
YT14B-BS	12	6 1/8	2 3/4	5 3/4	150	70	145		11.8	11	0.60	1.2	210
YTX14-BS	12	6	3 7/16	5 3/4	150	87	145		10.1	5	0.69	1.4	200
YTX14L-BS	12	6	3 7/16	5 3/4	150	87	145		10.1	5	0.69	1.4	200
YTX15L-BS	13	6 7/8	3 7/16	5 1/8	175	87	130		11.0	4	0.69	1.3	230
YTX16-BS	14	6	3 7/16	6 3/8	150	87	161		12.6	4	0.78	1.4	230
YTX16-BS-1	14	6	3 7/16	6 3/8	150	87	161		12.6	1	0.78	1.4	230
YT19BL-BS	17.7	7 1/4	3 3/16	6 11/16	184	81	170		12.5	10	0.95	1.8	170
YTX20-BS	18	6 7/8	3 7/16	6 1/8	175	87	155		13.9	4	0.93	1.8	270
YTX20L-BS	18	6 7/8	3 7/16	6 1/8	175	87	155		13.9	4	0.93	1.8	270

^K Available at Kawasaki dealers only
^(S) Includes spacer

BATTERY SPECIFICATIONS

HIGH PERFORMANCE, CONVENTIONAL (Yumicron)

12 VOLT

Battery Type	Capacity Ah (10-HR)	Dimensions – Inches (± 1/16 in)			Dimensions – Millimeters (± 2 mm)			Assembly Figure (As Per Cover Polarity)	Approx Weight w/out Acid (lbs.)	Terminal Type (Refer to page 10)	Acid Volume (oz.)	Regular Charge Current (Amp)
		L	W	H	L	W	H					
YB2.5L-C	2.5	3 3/16	2 3/4	4 1/8	80	70	105		1.7	-	8.1	0.3
YB2.5L-C-1	2.5	3 3/16	2 3/4	4 1/8	80	70	105		1.7	-	8.1	0.3
YB3L-A	3	3 7/8	2 1/4	4 3/8	98	56	110		2.5	6	8.1	0.3
YB3L-B	3	3 7/8	2 1/4	4 3/8	98	56	110		2.5	6	8.1	0.3
YB4L-A ^D	4	4 3/4	2 3/4	3 5/8	120	70	92		2.8	5	10.1	0.4
YB4L-B	4	4 3/4	2 3/4	3 5/8	120	70	92		2.8	5	10.1	0.4
YB5L-B	5	4 3/4	2 3/8	5 1/8	120	60	130		3.5	6	12.2	0.5
YB7-A	8	5 5/16	3	5 1/4	135	75	133		5.1	6	20.3	0.8
YB7B-B	7	6	2 3/8	5 1/8	150	60	130		4.0	6	16.9	0.7
YB7C-A	8	5 1/8	3 9/16	4 1/2	130	90	114		5.1	1	20.3	0.8
YB7L-B ^D	8	5 5/16	3	5 1/4	135	75	133		5.1	6	20.3	0.8
YB9A-A	9	5 5/16	3	6 1/8	135	75	155		5.3	6	20.3	0.9
YB9L-A2	9	5 5/16	3	5 1/2	135	75	139		5.3	2	20.3	0.9
YB9-B	9	5 5/16	3	5 1/2	135	75	139		5.3	6	20.3	0.9
YB9L-B	9	5 5/16	3	5 1/2	135	75	139		5.3	6	20.3	0.9
YB10A-A2	11	5 5/16	3 9/16	6 1/8	135	90	155		7.0	8	27.0	1.1
YB10L-A2	11	5 5/16	3 9/16	5 3/4	135	90	145		7.0	8	27.0	1.1
YB10L-B	11	5 5/16	3 9/16	5 3/4	135	90	145		7.0	6	27.0	1.1
YB10L-B2	11	5 5/16	3 9/16	5 3/4	135	90	145		7.0	8	27.0	1.1
YB12A-A	12	5 5/16	3 3/16	6 5/16	134	80	160		6.8	6	27.0	1.2
YB12A-A**	12	5 5/16	3 3/16	6 5/16	134	80	160		6.8	6	27.0	1.2
YB12AL-A ^D	12	5 5/16	3 3/16	6 5/16	134	80	160		6.8	6	25.4	1.2
YB12AL-A2 [*]	12	5 5/16	3 3/16	6 5/16	134	80	160		6.8	8	25.4	1.2
YB12A-B	12	5 5/16	3 3/16	6 5/16	134	80	160		6.8	6	25.4	1.2
YB12B-B2	12	6 5/16	3 9/16	5 1/8	160	90	130		7.1	8	27.0	1.2
YB12C-A	12	5 5/16	3 9/16	6 7/8	134	80	175		7.1	4	27.0	1.2
YB14-A2	14	5 5/16	3 1/2	6 9/16	134	89	166		7.6	8	30.4	1.4
YB14A-A1	14	5 5/16	3 1/2	6 15/16	134	89	176		7.9	6	30.4	1.4
YB14A-A2	14	5 5/16	3 1/2	6 15/16	134	89	176		7.9	8	30.4	1.4
YB14L-A1	14	5 5/16	3 1/2	6 9/16	134	89	166		7.6	1	30.4	1.4

* Includes terminal adaptor for converting to top mount.
 ** When ordering this battery, specify terminal adaptor.
 ▲ When ordering this battery, specify sensor.
 D Discontinued

BATTERY SPECIFICATIONS

HIGH PERFORMANCE, CONVENTIONAL (Yumicron)

12 VOLT

Battery Type	Capacity Ah (10-HR)	Dimensions – Inches (± 1/16 in)			Dimensions – Millimeters (± 2 mm)			Assembly Figure (As Per Cover Polarity)	Approx Weight w/out Acid (lbs.)	Terminal Type (Refer to page 10)	Acid Volume (oz.)	Regular Charge Current (Amp)
		L	W	H	L	W	H					
YB14L-A2	14	5 5/16	3 1/2	6 9/16	134	89	166		7.6	8	30.4	1.4
YB14L-B2	14	5 5/16	3 1/2	6 9/16	134	89	166		7.6	8	30.4	1.4
YB14-B2	14	5 5/16	3 1/2	6 9/16	134	89	166		7.6	8	30.4	1.4
SYB14L-A2 †	14	5 5/16	3 1/2	6 9/16	134	89	166		7.6	8	30.4	1.4
YB16AL-A2	16	8 1/8	2 13/16	6 7/16	207	71.5	164		8.6	2	37.2	1.6
HYB16A-AB	16	6	3 5/8	7 1/16	151	91	180		8.5	7	30.4	1.6
YB16-B	19	6 7/8	4	6 1/8	175	100	155		10.5	6	40.6	1.9
YB16L-B	19	6 7/8	4	6 1/8	175	100	155		10.5	6	40.6	1.9
YB16B-A	16	6 5/16	3 9/16	6 3/8	160	90	161		8.4	4	33.8	1.6
YB16B-A1*	16	6 5/16	3 9/16	6 3/8	160	90	161		8.4	7	33.8	1.6
YB16C-B	19	6 7/8	4	6 7/8	175	100	175		10.1	5	40.6	1.9
YB16CL-B	19	6 7/8	4	6 7/8	175	100	175		10.1	5	40.6	1.9
YB18-A	18	7 1/8	3 9/16	6 3/8	180	90	162		9.4	7	40.6	1.8
YB18L-A	18	7 1/8	3 9/16	6 3/8	180	90	162		9.4	7	40.6	1.8
Y50-N18A-A	20	8 1/8	3 9/16	6 15/16	205	90	176		11.2	7	50.7	2.0
Y50-N18L-A	20	8 1/8	3 9/16	6 3/8	205	90	162		11.2	7	44.0	2.0
Y50-N18L-A-CX	20	8 1/8	3 9/16	6 3/8	205	90	162		11.2	7	44.0	2.0
Y50-N18L-A3	20	8 1/8	3 9/16	6 3/8	205	90	162		11.2	4	44.0	2.0
SY50-N18L-AT †	20	8 1/8	3 9/16	6 3/8	205	90	162		11.2	7	44.0	2.0
YB30L-B	30	6 5/8	5 3/16	6 15/16	168	132	176		14.1	4	57.5	3.0
YB30CL-B	30	6 5/8	5 3/16	7 9/16	168	132	192.2		14.5	4	57.5	3.0
51814	19****	7 7/16	3 1/4	6 7/8	186	82	171		9.4	10	33.8	1.9
51913	19****	7 7/16	3 1/4	6 7/8	186	82	171		9.4	10	33.8	1.9
53030	30****	7 7/16	5 1/8	6 7/8	186	130	171		16.1	10	54.1	3.0

* Includes terminal adaptor for converting to side mount
 **** DIN Standard @ 20 hr. rate
 † This battery includes a sensor
 † Discontinued

BATTERY SPECIFICATIONS

CONVENTIONAL

6 VOLT

Battery Type	Capacity Ah (10-HR)	Dimensions – Inches (± 1/16 in)			Dimensions – Millimeters (± 2 mm)			Assembly Figure (As Per Cover Polarity)	Approx Weight w/out Acid (lbs.)	Terminal Type (Refer to page 10)	Acid Volume (oz.)	Regular Charge Current (Amp)
		L	W	H	L	W	H					
6N2-2A	2	2 3/4	1 7/8	3 3/4	70	47	96		1.0	-	3.4	0.2
6N2-2A-3	2	2 3/4	1 7/8	3 3/4	70	47	96		1.0	-	3.4	0.2
6N2-2A-4	2	2 3/4	1 7/8	3 3/4	70	47	96		1.0	-	3.4	0.2
6N2-2A-8	2	2 3/4	1 7/8	3 3/4	70	47	96		1.0	-	3.4	0.2
6N2A-2C	2	2 3/4	1 7/8	4 3/16	70	47	106		1.0	-	3.4	0.2
6N2A-2C-1 **	2	2 3/4	1 7/8	4 3/16	70	47	106		1.0	-	3.4	0.2
6N2A-2C-3	2	2 3/4	1 7/8	4 3/16	70	47	106		1.0	-	3.4	0.2
6N4-2A	4	2 13/16	2 13/16	3 3/4	71	71	96		1.3	-	6.8	0.4
6N4-2A-4	4	2 13/16	2 13/16	3 3/4	71	71	96		1.3	-	6.8	0.4
6N4-2A-5	4	2 13/16	2 13/16	3 3/4	71	71	96		1.3	-	6.8	0.4
6N4-2A-6	4	2 13/16	2 13/16	3 3/4	71	71	96		1.3	-	6.8	0.4
6N4-2A-8	4	2 13/16	2 13/16	3 3/4	71	71	96		1.3	-	6.8	0.4
6N4A-4D ^D	4	2 3/8	2 1/4	5 1/8	61	57	131		1.7	-	6.8	0.4
6N4B-2A	4	4	1 7/8	3 3/4	102	48	96		1.7	-	6.8	0.4
6N4B-2A-3	4	4	1 7/8	3 3/4	102	48	96		1.7	-	6.8	0.4
6N4C-1B	4	2 13/16	2 13/16	4 1/8	71	71	105		1.4	-	6.8	0.4
6N5.5-1D	5.5	3 9/16	2 3/4	3 15/16	90	70	100		1.8	-	10.1	0.6
6N6-3B	6	3 7/8	2 1/4	4 3/8	99	57	111		2.0	6	10.1	0.6
6N6-3B-1	6	3 7/8	2 1/4	4 3/8	99	57	111		2.0	6	10.1	0.6
6N6-1D-2	6	3 7/8	2 1/4	4 3/8	99	57	111		2.0	-	10.1	0.6
6N11-2D	11	5 7/8	2 3/4	3 15/16	150	70	100		3.5	6	13.5	1.1
6N11A-1B	11	4 13/16	2 7/16	5 1/8	122	62	131		3.5	6	13.5	1.1
6N12A-2D	12	6 1/8	2 1/4	4 9/16	156	57	116		3.8	6	15.2	1.2
B38-6A	13	4 11/16	3 1/4	6 15/16	119	83	161		4.7	6	21.0	1.3

** 6N2A-2C-1 replaces B60-6
^D Discontinued

TRACTOR TERMINALS & BATTERY LAYOUTS

CONVENTIONAL

12 VOLT

Battery Type	Capacity Ah (10-HR)	Dimensions – Inches (± 1/16 in)			Dimensions – Millimeters (± 2 mm)			Assembly Figure (As Per Cover Polarity)	Approx Weight w/out Acid (lbs.)	Terminal Type (Refer to page 10)	Acid Volume (oz.)	Regular Charge Current (Amp)
		L	W	H	L	W	H					
12N5-3B	5	4 3/4	2 3/8	5 1/8	120	60	130		3.1	6	13.5	0.5
12N5-4B	5	4 3/4	2 3/8	5 1/8	120	60	130		3.1	6	13.5	0.5
12N5.5-3B	5.5	5 5/16	2 3/8	5 1/8	135	60	130		4.3	6	13.5	0.6
12N5.5-4A	5.5	5 5/16	2 3/8	5 1/8	135	60	130		4.3	2	13.5	0.6
12N5.5A-3B	5.5	4 1/16	3 9/16	4 1/2	103	90	114		4.3	6	16.9	0.6
12N7-3B	7	5 5/16	3	5 1/4	135	75	133		4.9	6	16.9	0.7
12N7-4A	7	5 5/16	3	5 1/4	135	75	133		4.9	6	16.9	0.7
12N7-4B	7	5 5/16	3	5 1/4	135	75	133		4.9	6	16.9	0.7
12N7D-3B	7	5 5/16	3	5 15/16	135	75	150		4.9	6	20.3	0.7
12N9-3A	9	5 5/16	3	5 1/2	135	75	139		5.4	9	20.3	0.9
12N9-4B-1	9	5 5/16	3	5 1/2	135	75	139		5.4	6	20.3	0.9
12N12A-4A-1	12	5 5/16	3 3/16	6 5/16	134	80	160		6.8	6	23.7	1.2
12N14-3A	14	5 5/16	3 1/2	6 9/16	134	89	166		7.5	8	27.0	1.4
YHD-12H	29	8 1/8	5 1/4	6 1/2	206	133	165		13.3	9	67.6	2.8

TRACTOR TERMINALS & BATTERY LAYOUTS

TERMINALS (measurements in inches)

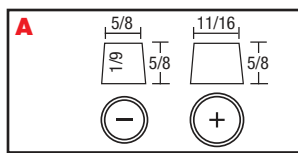

Standard Terminal

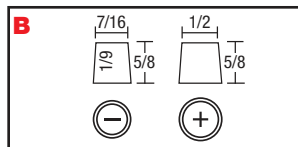

Small Terminal

BATTERY LAYOUTS

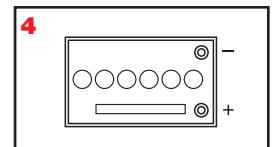
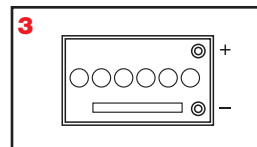
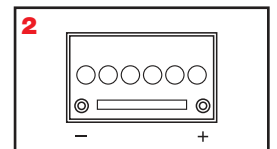
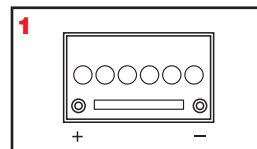

Tractor Batteries on page 17

BATTERY UPGRADE CROSS REFERENCE

JIS Type	Reference Number	Plate / Cell	Capacity Ah ▲ (5 hr)	Capacity Ah ▲ (20 hr)	Cranking Performance ▲ (Amps 0 °F)	Reserve Capacity Minutes (80 °F)	Overall Dimensions (inches)			Shipping Weight Dry (lbs.)	Volume Of Acid (oz.)	Charging Current (Amp)	See Key	
							L	W	H				Terminal	Layout
*36B20L (S)	40B19L(S) NS40ZL(S)	9	28	35	275	52	7 3/4	5 1/16	8 15/16	17.9	84.6	3.5	A	2
46B24R	NS60	13	36	45	330	75	9 3/8	5 1/16	8 15/16	20.1	109.0	4.5	B	1
*46B24L (S)	NS60L(S)	13	36	45	330	75	9 3/8	5 1/16	8 15/16	20.1	109.5	4.5	A	2
36B20L	40B19L/NS40ZL	9	28	35	275	52	7 3/4	5 1/16	8 15/16	17.9	91.7	3.5	B	2
*55B24L (S) D4	NX100S6L(S)	13	36	45	410	70	9 3/8	5 1/16	8 15/16	21.3	109.3	4.5	A	2
95E41R	N100	17	80	100	475	200	16 3/8	6 15/16	9 3/8	38.1	233.1	10	A	1
115F51	N120	21	96	120	420	240	19 7/8	7 3/16	10 1/8	48.7	317.4	12.0	A	3
115F51L D4	N120L	21	96	120	420	240	19 7/8	7 3/16	10 1/8	48.7	317.4	12.0	A	4
145F51	NS150	25	120	150	760	296	19 7/8	7 3/16	10 1/8	56.2	370.3	14.0	A	3
145G51L D4	N150L D4	23	120	150	685	240	20 3/16	8 3/4	10 1/8	63.8	337.8	15	A	4

* (S) Signifies Standard Terminal
D4 Discontinued

▲ Figures based on JIS/SAE specifications and reference only

BATTERY UPGRADE CROSS REFERENCE

GYZ Series	AGM Factory Activated	AGM High Performance	AGM	Yumicron	Conventional
-	-	YTZ5S-BS	YTX4L-BS	YB4L-A, YB4L-B	-
-	YTZ7S	-	YTX5L-BS	-	-
-	-	-	-	YB5L-B	12N5-3B
-	-	YTZ8V	YTX7L-BS	-	-
-	-	-	-	YB7L-B	12N7-3B
-	-	-	-	YB7-A	12N7-4A
-	-	-	-	YB9-B	12N9-4B-1
-	-	-	-	YB9L-B	12N9-3B (Discontinued)
-	-	-	-	YB10L-A2	12N10-3A-2 (Discontinued)
-	-	-	-	YB12A-A	12N12A-4A-1
GYZ16H ¹⁰	YTX14H	YTX14H-BS	YTX14-BS	-	-
-	YTX14AH	YTX14AH-BS	-	YB14-A2, YB14-B2	-
-	YTX14AH ^{3,4}	YTX14AH-BS ^{3,4}	-	YB14A-A1, YB14A-A2	-
-	YTX14AHL	YTX14AHL-BS	-	YB14L-A2	12N14-3A
-	YTX14AHL	YTX14AHL-BS	-	YB14L-B2	-
GYZ16HL	YTX14L	-	YTX14L-BS	-	-
-	-	-	YT19BL-BS	51913, 51814	-
-	YTX20CH	YTX20CH-BS	YTX16-BS	-	-
GYZ20H ⁷	YTX20H ⁷ , YTX20 ²	YTX20H-BS ²	YTX20-BS ²	YB16-B, YB16-B-CX	-
GYZ20H	YTX20H, YTX20 ²	YTX20H-BS ²	YTX20-BS ²	YB18-A	-
-	YTX20HL-PW ⁶	YTX20HL-BS-PW ⁶	-	YB16CL-B	-
GYZ20HL ⁷ , GYZ20L	YTX20HL, YTX20L	YTX20HL-BS	YTX20L-BS	YB16HL-A-CX	-
GYZ20HL, GYZ20L	YTX20HL, YTX20L ²	YTX20HL-BS ²	YTX20L-BS ²	YB16L-B	-
GYZ20HL, GYZ20L	YTX20HL, YTX20L ²	YTX20HL-BS ²	YTX20L-BS ²	YB18L-A	-
GYZ20HL ⁸ , GYZ20L	YTX20HL, YTX20L	YTX20HL-BS ²	YTX20L-BS	-	-
-	YTX24HL ⁹	YTX24HL-BS ³	-	Y50-N18L-A, Y50-N18L-A-CX	-
-	YTX24HL	YTX24HL-BS	-	Y50-N18L-A3	-
-	YTX24HL ^{1,3}	YTX24HL-BS ^{1,3}	-	SY50-N18-AT	-
-	YIX20HL ⁹	YIX20HL-BS ⁹ > YTX20HL-BS	-	-	-
GYZ32HL	YIX30L ⁹	YIX30L-BS ⁹	-	YB30L-B	-
-	YIX30L-PW ^{5,9}	YIX30L-BS-PW ^{5,9}	-	YB30CLB	-
-	YIX30L ⁹	YIX30L-BS ⁹	-	53030	Y60-N24AL-B (Discontinued)

- Eliminates need for sensor (needs to be disabled).
- The YTX20 series batteries may be used as an optional upgrade, but some modification to the hold down may be necessary. See battery label for retrofit cautions.
- Top and front terminal mounts only.
- Includes 10mm height spacer.

- Includes 17mm height spacer.
- Includes 20mm height spacer for use in replacing YB16CL-B.
- For Harley-Davidson Models only.
- GYZ20HL has flush terminals, different than OEM battery on Honda GL1800.
- Preferred cold climate performance.
- Mount through front only.

SCOOTER APPLICATIONS

CC	Model	Year	GYZ Series AGM	High Performance AGM	AGM	Yumicron / Conventional	CC	Model	Year	GYZ Series AGM	High Performance AGM	AGM	Yumicron / Conventional
900	Defender	'22	-	YX30L-BS	-	-	KYMCO						
	Traxter HD9	'22	-	YTX20HL ^{FA}	YTX20L ^{FA}	-	700	UXV700	'17	GYZ20HL	YTX20HL-BS	YTX20L-BS	-
800	Commander	'11-'21	GYZ20HL	YTX20HL ^{FA}	YTX20L ^{FA}	-	500	UXV500	'17	GYZ20HL	YTX20HL-BS	YTX20L-BS	-
	Defender, DPS, Base, STD	'16-'21	GYZ20HL	YTX20HL ^{FA}	YTX20L ^{FA}	-	450	UXV450	'17	GYZ20HL	YTX20HL-BS	YTX20L-BS	-
	Defender XT,CAB,MOS	'16-'21	GYZ32HL	YX30L	-	-	POLARIS						
	Maverick	'18-'21	GYZ20HL	YTX20HL-BS	YTX20L-BS	-	2.0L	RZR Pro R	'22	GYZ32HL	YX30L	-	-
	Traxter DPS, Base, STD	'16-'21	GYZ20HL	YTX20HL-BS	YTX20L-BS	-	1000	RZR XP1000, XP 4, Turbo 4, Turbo S Tractor	'14-'22	-	YBX9140R	-	-
	Traxter Pro, XT	'17-'21	GYZ32HL	YX30L-BS	-	-		RZR Pro XP	'22	GYZ32HL	YX30L	-	-
700	Commander	'22	GYZ20HL	YTX20HL	-	-		RZR RS1 Turbo Pro	'18-'22	-	YX30L	-	-
	Defender HD7	'22	-	YTX20HL	-	-		Ranger BC	'20-'21	GYZ32HL	YX30L	-	-
	Traxter HD7	'22	-	YTX20HL	-	-		Ranger / General	'16-'22	-	YBX9140R	-	-
427	Traxter, Defender	'17-'21	GYZ20HL	YTX20HL-BS	YTX20L-BS	-		Ranger Diesel, XP	'15-'22	-	YBX9140R	-	-
								Ranger 48V	'20-'22	-	YBX9140R	-	-

CF MOTO

All	All Models	All	GYZ32HL	YX30L-BS	-	-
-----	------------	-----	---------	----------	---	---

HONDA

1000	Pioneer 1000	'16-'21	GYZ16H	-	-	-
	Talon	'19-'22	GYZ20HA	-	-	-
700	MUV700 Big Red	'08-'13	GYZ16H	YTX14H-BS	YTX14-BS	-
520	Pioneer 700	'14-'20	GYZ16H	YTX14H-BS	YTX14-BS	-
	Pioneer 520	'21-'22	GYZ16H	YTX14H-BS	YTX14-BS	-
500	Pioneer 500	'15-'18	GYZ16H	-	-	-
	Pioneer 500	'19-'22	GYZ16H	YTX14H-BS	YTX14-BS	-

KAWASAKI

1000	Mule Pro DX, DXT	'21-'22	-	YBX9140R	-	-
	Teryx KRX1000	'21-'22	-	YBX9140R	-	-
990	Mule Pro DXT, DX	'16-'18	Not available	-	-	-
950	KAF950, Mule 2510, 3010 Diesel	'10	Not available	-	-	-
	Mule 4010 Diesel	'11-'13	Not available	-	-	-
820	Mule Pro FXT, FX	'15-'22	-	YBX9140R	-	-
800	Teryx All Models (US)	'14-'22	Not available	-	-	-
	Teryx All Models (CN)	'14-'20	GYZ20HL	YTX20HL-BS	YTX20L-BS	-
750	Teryx All Models (US)	'08-'13	Not available	-	-	-
	Teryx All Models (CN)	'08-'13	GYZ16H	-	KMX14-BS ^K	-
700	Mule Pro MX	'19-'22	Not available	-	-	-
620	KAF620, Mule 3010 4x4, Advantage Classic	'03-'07	GYZ20HL	YTX20HL-BS	YTX20L-BS	-
	KAF620, Mule 2500, 2510, 2520		-	YTX20HL-PW	-	YB16CL-B
	KAF620, Mule 3000, 3010, 3020		GYZ20HL	YTX20HL-BS	YTX20L-BS	-
	Mule 4000	'09-'20	Not available	-	-	-
	KAF620F, Mule 4010 4x4 (US)	'09-'17	Not available	-	-	-
	KAF620F, Mule 4010 4x4 (CN)	'09-'20	GYZ20HL	YTX20HL-BS	YTX20L-BS	-
	Mule 4010 Trans4x4, Diesel, Mule 4000	'09-'17	Not available	-	-	-
540	KAF540, Mule 2010, 2020, 2030		-	YTX20HL-PW	-	YB16CL-B
450	KAF450, Mule 1000		-	YTX20HL-PW	-	YB16CL-B
400	Mule 600, 610, 610XC	'05-'16	-	YTX14AH-BS	-	YB14A-A2
	Mule SX	'17-'22	-	YTX14AH-BS	-	YB14A-A2
300	KAF300, Mule 500, 520, 550		-	YTX14AH-BS	-	YB14A-A2

SUZUKI

620	QUV620F	'05	GYZ20HL	YTX20HL-BS	YTX20L-BS	-
-----	---------	-----	---------	------------	-----------	---

YAMAHA

	Rhino	All	Not available	-	-	-
1000	YZZ1000R	'16-'22	Not available	-	-	-
700	Viking	'14-'22	Not available	-	-	-
	Wolverine	'16-'22	Not available	-	-	-

SCOOTER APPLICATIONS

CC	Model	Year	GYZ Series AGM	High Performance AGM	AGM	Yumicron / Conventional	CC	Model	Year	GYZ Series AGM	High Performance AGM	AGM	Yumicron / Conventional
APRILIA							50	SR50	'09-'15	-	-	-	YB9-B
850	SRV850	'12-'13	GYZ16H	YTX14H-BS	YTX14-BS	-		Sport City	'08-'13	-	-	-	YB9-B
500	Scarabeo	'09-'13	-	-	YTX12-BS	-	BMW						
300	Atlantic	'12	-	-	-	YB12AL-A	650	C650 GT, Sport	'11-'18	GYZ16H	YTX14H-BS	YTX14-BS	-
250	Sport City	'09-'13	-	-	YTX12-BS	-		C650 Evolution	'16-'18	-	-	YTX9-BS	-
200	Scarabeo	'09-'13	-	-	YTX12-BS	-	600	C600, Sport	'13-'16	GYZ16H	YTX14H-BS	YTX14-BS	-
150	Mojito	'09-'10	-	YTZ8V	YTX7L-BS	-		C600	'11-'12	-	YTZ14S	-	-
125	Sport City	'08-'13	-	-	-	YB9-B							
100	Scarabeo ST	'09-'13	-	-	-	YB9-B							

^K Available at Kawasaki dealers only

^{FA} Must use factory activated battery

PWC (PERSONAL WATERCRAFT) APPLICATIONS

PWC (PERSONAL WATERCRAFT) APPLICATIONS

CC	Model	Year	GYZ Series AGM	High Performance AGM	AGM	Yumicron / Conventional	CC	Model	Year	GYZ Series AGM	High Performance AGM	AGM	Yumicron / Conventional
AQUA-JET CO.							JH750 SS, ST, Xi, XiR	'92-'99	-	YTX20HL-PW	-	-	YB16CL-B
430	Aqua-Jet SX1	'91	-	-	-	YB16-B	JH750 ST, Zxi	'95-'97	GYZ20HL	YTX20HL-BS	YTX20L-BS	-	-
432	Aqua-Jet Sx1	'89-'90	-	-	-	YB16-B	JH750 SX, ZX	'92-'95	-	YTX20HL-PW	-	-	YB16CL-B
ARCTIC CAT							JS750 SX, ZX	'92-'95	-	YTX20HL-PW	-	-	YB16CL-B
770	Tiger Shark	'97-'99	-	YTX14AHL-BS	-	YB14L-A2	JS750 SXi, SXi Pro	'95-'02	GYZ20HL	YTX20HL-BS	YTX20L-BS	-	-
640	Tiger Shark	'97-'99	-	YTX14AHL-BS	-	YB14L-A2	JT750 STS, STX	'96-'98	GYZ20HL	YTX20HL-BS	YTX20L-BS	-	-
	Tiger Shark	'93-'96	-	-	-	YB16CL-B	JF650 TS	'89-'96	-	YTX20HL-PW	-	-	YB16CL-B
BRP (SEA-D00)							JF650 X2	'86-'95	-	YTX20HL-PW	-	-	YB16CL-B
1630	Fish Pro	'19-'22	GYZ20HL	YTX20HL	YTX20L	-	JL650 SC	'91-'95	-	YTX20HL-PW	-	-	YB16CL-B
	GTI, GTR, GTX, RXP, RXT, WAKE	'20-'22	GYZ20HL	YTX20HL	YTX20L	-	JS650 SX	'87-'95	-	YTX20HL-PW	-	-	YB16CL-B
1500	GTI, GTR, GTS, GTX, RXT, RXP, WAKE Pro	'16-'22	GYZ20HL	YTX20HL-BS	YTX20L-BS	-	JS550	'82-'85	GYZ20HL	YTX20HL-BS	YTX20L-BS	YB16L-B	-
	GTI, GTX, GTR RXP, RXT, WAKE	'15	-	YIX30L-PW	-	YB30CL-B	JS550, SX	'86-'95	-	YTX20HL-PW	-	-	YB16CL-B
	GTX 4-Tec, RXP	'03-'07	-	YIX30L-PW	-	YB30CL-B	440 JS440	'87-'92	-	YTX20HL-PW	-	-	YB16CL-B
	All Models	'88-'93	GYZ20HL	YTX20HL-PW	YTX20L-BS	YB16CL-B	JS440	'77-'86	GYZ20HL	YTX20HL-BS	YTX20L-BS	YB16L-B	-
	All Other Models	'94-'07	-	YTX20HL-PW	-	YB16CL-B	400 JS400	'76	GYZ20HL	YTX20HL-BS	YTX20L-BS	YB16L-B	-
900	SPARK	'14-'22	GYZ20HL	YTX20HL-BS	YTX20L-BS	-	300 JS300 TS, SX	'86-'91	-	YTX20HL-PW	-	-	YB16CL-B
	GTI 90	'18-'22	GYZ20HL	YTX20HL-BS	YTX20L-BS	-	POLARIS						
780	3D	'07	-	YTX20HL-BS-PW	-	YB16CL-B	All All Models	All	-	YTX20HL-PW	-	-	YB16CL-B
HONDA							S.O.S. MARINE MFG						
1470	AquaTrax F-15, F-15X	'03-'13	GYZ20HL	YTX20HL-BS	YTX20L-BS	-	All All Models	All	GYZ20H	YTX20H-BS	YTX20-BS	-	-
1235	AquaTrax F/R-12, F/R-12X	'02-'09	GYZ20HL	YTX20HL-BS	YTX20L-BS	-	ULTRANAUTICS						
KAWASAKI (JET SKI)							1250 Jet Star1250 (Boat)	'88-'90	-	-	-	-	53030
1500	JT1500-A, STX, STX-15F	'04-'19	GYZ20HL	YTX20HL-BS	YTX20L-BS	-	Jet Star1260 (Boat)	91	-	-	-	53030	
	JT1500B, C, 250X, Ultra LX, 260(LX), 300(LX)	'07-'20	GYZ20HL	YTX20HL-BS	YTX20L-BS	-	800 All Models	'87-'92	-	-	-	53030	
	SKR, STX160	'17-'22	GYZ20HL	YTX20HL-BS	YTX20L-BS	-	Wet Bike	'85-'86	-	-	-	YHD-12H	
	Ultra 310, LX, R, X	'14-'22	GYZ20HL	YTX20HL-BS	YTX20L-BS	-	WET JET INTERNATIONAL						
1200	JH1200-A, B Ultra 150	'99-'05	GYZ20HL	YTX20HL-BS	YTX20L-BS	-	All All Models	All	GYZ20H	YTX20H	YTX20-BS	-	-
	JH1200-A-B, C, STX-R, STX-12F	'02-'07	GYZ20HL	YTX20HL-BS	YTX20L-BS	-	YAMAHA						
1100	JH1100 Zxi	'96-'03	GYZ20HL	YTX20HL-BS	YTX20L-BS	-	All All Wave Runner Models	'87-'08	-	YTX20HL-PW	-	-	YB16CL-B
	JH1100-B Ultra 130	'01-'04	GYZ20HL	YTX20HL-BS	YTX20L-BS	-	1800 FX, FZR, FZS, VXS, VXR	'09-'20	-	YTX20HL-PW	-	-	YB16CL-B
	JT1100 STX	'97-'03	GYZ20HL	YTX20HL-BS	YTX20L-BS	-	FX	'21-'22	-	YTX20HL-BS	YTX20L-BS	-	-
900	JH900 Zxi	'95-'97	GYZ20HL	YTX20HL-BS	YTX20L-BS	-	1050 VX, V1	'09-'20	-	YTX20HL-PW	-	-	YB16CL-B
	JT900 STS, STX	'97-'05	GYZ20HL	YTX20HL-BS	YTX20L-BS	-	EX, EXR, SJ	'21-'22	-	YTX20HL-BS	YTX20L-BS	-	-
800	JS800 SX-R	'03-'13	GYZ20HL	YTX20HL-BS	YTX20L-BS	-	Jet Blaster	'21-'22	-	YTX20HL-BS	YTX20L-BS	-	-
750	JH750 B1-b3	'93-'95	-	YTX20HL-PW	-	YB16CL-B	1049 EX	'17-'19	-	YTX20HL-PW	-	-	YB16CL-B
	JH750 E1,F2,G1,G2	'95-'99	GYZ20HL	YTX20HL-BS	YTX20L-BS	-	700 Superjet	'09-'17	-	YTX20HL-PW	-	-	YB16CL-B

SNOWMOBILE APPLICATIONS

CC	Model	Year	GYZ Series AGM	High Performance AGM	AGM	Yumicron / Conventional	CC	Model	Year	GYZ Series AGM	High Performance AGM	AGM	Yumicron / Conventional
ARCTIC CAT							700 Riot 8000	'20-'22	GYZ20H	YTX20H-BS	YTX20-BS	-	-
1100	Z1, TZ1, F1100, M1100, Bearcat Z1	'01-'14	GYZ20H	YTX20H-BS	YTX20-BS	-	700 Bearcat 3000, Pantera 3000	'16-'19	GYZ20H	YTX20H-BS	YTX20-BS	-	-
	ZR 7000, ZR 9000	'14-'21	GYZ20H	YTX20H-BS	YTX20-BS	-	600 ZR 3000, Norseman 3000	'17-'19	GYZ20H	YTX20H-BS	YTX20-BS	-	-
	XF1100, T1100, ZR 5000	'14-'17	GYZ20H	YTX20H-BS	YTX20-BS	-	600 ZR 6000	'14-'21	GYZ20H	YTX20H-BS	YTX20-BS	-	-
	XF 7000, 8000, 9000	'14-'19	GYZ20H	YTX20H-BS	YTX20-BS	-	M 6000	'15-'19	GYZ20H	YTX20H-BS	YTX20-BS	-	-
	M 8000, 9000	'14-'19	GYZ20H	YTX20H-BS	YTX20-BS	-	XF 6000	'17-'18	GYZ20H	YTX20H-BS	YTX20-BS	-	-
	M 7000	'15-'16	GYZ20H	YTX20H-BS	YTX20-BS	-	Norseman 6000	'18-'19	GYZ20H	YTX20H-BS	YTX20-BS	-	-
	Pantera 7000	'15-'19	GYZ20H	YTX20H-BS	YTX20-BS	-	Riot 6000	'20-'22	GYZ20H	YTX20H-BS	YTX20-BS	-	-
	Bearcat 7000	'15-'19	GYZ20H	YTX20H-BS	YTX20-BS	-	570 F570, T570	'08-'14	GYZ20H	YTX20H-BS	YTX20-BS	YB18-A	-
	Bearcat 5000	'15-'17	GYZ20H	YTX20H-BS	YTX20-BS	-	565 Lynx 2000	'15-'20	GYZ20H	YTX20H-BS	YTX20-BS	-	-
800	F8 LXR, F800, M800, XF800	'07-'13	GYZ20H	YTX20H-BS	YTX20-BS	-	Bearcat 2000	'17-'20	GYZ20H	YTX20H-BS	YTX20-BS	-	-
	ZR 8000	'14-'21	GYZ20H	YTX20H-BS	YTX20-BS	-	500 F5 LXR	'07-'14	GYZ20H	YTX20H-BS	YTX20-BS	YB18-A	-
	Norseman 8000	'19-'22	GYZ20H	YTX20H-BS	YTX20-BS	-	4 Stroke Trail, Touring	'02-'03	-	YTX24HL-BS	-	Y50-N18L-A-CX	-
							Bearcat 340, 440	'95-'00	-	YTX14AH-BS	-	-	YB14-A2

■ Top and front terminal mounts only
† This battery includes a sensor

SNOWMOBILE APPLICATIONS

CC	Model	Year	GYZ Series AGM	High Performance AGM	AGM	Yumicron / Conventional	CC	Model	Year	GYZ Series AGM	High Performance AGM	AGM	Yumicron / Conventional
	Switchback, RMK, Indy, Matryx, Patriot Boost	'19-'22	-	YTX20CH-BS	-	-		VX700DX Vmax 700 Deluxe	'99-'00	-	YTX24HL-BS *	-	Y50-N18L-A-CX
800	Switchback, RMK	'10	GYZ20HL	YTX20HL-BS	YTX20L-BS	-		VX700ER Vmax 700 ER	'01-'02	-	YTX24HL-BS *	-	Y50-N18L-A-CX
	Rush, Switchback, RMK	'11-'20	-	YTX20CH ^{FA}	-	-		VX700XTCD Vmax 700 XTC Deluxe	'98	-	YTX24HL-BS *	-	Y50-N18L-A-CX
	Indy	'14-'16	-	YTX20CH ^{FA}	-	-	600	Transporter	'20-'22	GYZ20H	YTX20H-BS	-	-
	SKS	'16	-	YTX20CH ^{FA}	-	-		VT600 Venture 600	'97-'98	-	-	-	YB16AL-A2
	Titan SP, Adventure/XC	'18-'22	-	YTX20CH ^{FA}	-	-		VT600 Venture 600	'99-'06	-	YTX24HL-BS *	-	Y50-N18L-A-CX
750	FS/FST, Wide Trak	'06-'10	GYZ20HL	YTX20HL-BS	YTX20L-BS	-		VX600DX Vmax 600 Deluxe	'99-'01	-	YTX24HL-BS *	-	Y50-N18L-A-CX
	Turbo Switchback, Turbo Dragon	'06-'10	GYZ20HL	YTX20HL-BS	YTX20L-BS	-		VX600E/DX Vmax 600 LE/DX	'94-'96	-	-	-	YB16AL-A2
	Turbo LX, IQ	'08-'14	GYZ20HL	YTX20HL-BS	YTX20L-BS	-		VX600ER Vmax 600 ER	'02-'03	-	YTX24HL-BS *	-	Y50-N18L-A-CX
	FS Wide Trak	'10-'13	GYZ32HL	YX30L-BS	-	YB30L-B		VX600XTC Vmax 600 XTC	'97-'98	-	-	-	YB16AL-A2
650	Matryx, Indy, Nordicpro, Switchback	'22-	-	YTX20CH-BS	-	-	570	EX570E Exciter, II LE, Deluxe	'88-'93	-	-	-	YB16AL-A2
600	IQ Touring	'08	-	YTX14AH-BS	-	-	540	EC540 Excel	'79-'80	-	YTX24HL-BS	-	Y50-N18L-A-CX
	IQ, Shift, Switchback, RMK	'09-'11	GYZ20HL	YTX20HL-BS	YTX20L-BS	-		VK540E, M, II, III	'88-'05	-	-	-	YB16AL-A2
	Shift, Switchback, RMK	'09-'10	GYZ20HL	YTX20HL-BS	YTX20L-BS	-		VK540	'18-'22	-	-	-	YB16AL-A2
	Wide Trak	'10-'17	GYZ32HL	YX30L-BS	-	YB30L-B		XL540 XLV	'85-'90	-	-	-	YB16AL-A2
	Rush	'10-'19	-	YTX20CH ^{FA}	-	-	500	Phazer All Models	'07-'18	GYZ16H	YTX14H-BS	YTX14-BS	-
	Switchback, RMK	'12-'19	-	YTX20CH-BS	-	-		Venture Lite, MP, RS	'07-'18	GYZ16H	YTX14H-BS	YTX14-BS	-
	Indy, Voyager	'14-'22	-	YTX20CH-BS	-	-		PZ500DX Phazer 500 Deluxe	'01	-	-	-	YB16AL-A2
	Wide Trak	'14-'17	GYZ32HL	YX30L	YX30L-BS	YB30L-B		VT500 Venture 500	'97-'01	-	-	-	YB16AL-A2
550	IQ, LXT, Shift	'13	GYZ20HL	YTX20HL-BS	YTX20L-BS	-	500	VT500 Venture 500 XL	'99-'00	-	-	-	YB16AL-A2
	Indy, Voyager, Adventure, RMK	'14-'22	-	YTX20CH-BS	-	-		Phazer All Models	'07-'18	GYZ16H	YTX14H-BS	YTX14-BS	-
	Wide Trak	'16-'19	-	YTX20CH-BS	-	-		Venture Lite, MP, RS	'07-'18	GYZ16H	YTX14H-BS	YTX14-BS	-
544	Trail, Trail Touring	'09	-	YTX14AH-BS	-	YB14A-A2		PZ500DX Phazer 500 Deluxe	'01	-	-	-	YB16AL-A2
500	Wide Trak	'89-'14	-	YTX24HL-BS *	-	Y50-N18L-A-CX		VT500 Venture 500	'97-'01	-	-	-	YB16AL-A2
								VT500 Venture 500 XL	'99-'00	-	-	-	YB16AL-A2
								VX500E, FDX, ST Vmax	'94-'01	-	-	-	YB16AL-A2
							480	PZ480E Phazer Deluxe	'84-'89	-	YTX14AHL-BS	-	YB14L-A2
								PZ480E Phazer II LE, SS	'90-'98	-	YTX14AHL-BS	-	SYB14L-A2 †
								VT480 Venture GT	'92-'93	-	YTX14AHL-BS	-	SYB14L-A2 †
								VT480 Venture XL	'91-'97	-	YTX14AHL-BS	-	SYB14L-A2 †
								VT480TR Venture TR Electric	'98	-	YTX14AHL-BS	-	SYB14L-A2 †
							400	Transpotor Lite	'21-'23	GYZ20H	YTX20H-BS	-	-
								Venom	'21-'22	GYZ20H	YTX20H-BS	-	-
							340	CS340 Ovation Deluxe/LE	'89-'00	-	YTX14AHL-BS	-	SYB14L-A2 †
								EC340 Excel III	'81-'88	-	YTX14AHL-BS	-	SYB14L-A2 †
								ET340E Enticer	'79	-	YTX24HL-BS *	-	Y50-N18L-A-CX
								ET340E Enticer	'80	-	YTX14AHL-BS	-	SYB14L-A2 †
							300	CF300 Inviter	'86-'90	-	-	-	YB16AL-A2
							200	SXR2 Sno-Scout	'19-'22	-	-	YTX7L-BS	-
							125	SV125E Sno-Sport	'90-'91	-	YTX14AHL-BS	-	SYB14L-A2 †
							80	SV80E Sno-Scout	'88-'90	-	-	-	YB7L-B *

YAMAHA

1049	FX Nitro	'08-'14	GYZ20HL	YTX20HL-BS	YTX20L-BS	-
	RS Venture	'09-'22	GYZ20HL	YTX20HL-BS	YTX20L-BS	-
	RS Vector (All Models)	'10-'18	GYZ20HL	YTX20HL-BS	YTX20L-BS	-
	SR VIPER L/M/R/S/X	'14-'22	GYZ20H	YTX20H-BS	-	-
	VK Professional II	'16-'22	GYZ20HL	YTX20HL-BS	YTX20L-BS	-
1000	Apex	'06-'18	GYZ16H	YTX14H-BS	YTX14-BS	-
	Attak, GT	'06-'07	GYZ16H	YTX14H-BS	YTX14-BS	-
	RS1000S, GT, RS	'06-'14	GYZ20HL	YTX20HL-BS	YTX20L-BS	-
	RX1000R RX (All Models)	'03-'05	GYZ20HL	YTX20HL-BS	YTX20L-BS	-
	Sidewinder (All Models)	'17-'22	GYZ20H	YTX20H-BS	-	-
973	(RS)Vector all models	'05-'09	GYZ20HL	YTX20HL-BS	YTX20L-BS	-
	RS Viking Professional, VK Pro.	'06-'15	GYZ20HL	YTX20HL-BS	YTX20L-BS	-
	RS Venture	'05-'08	GYZ20HL	YTX20HL-BS	YTX20L-BS	-
	Nitro	'06-'07	GYZ20HL	YTX20HL-BS	YTX20L-BS	-
700	SKV700ER SKViper ER	'02-'05	-	YTX24HL-BS *	-	Y50-N18L-A-CX
	VT700 Venture 700	'98-'04	-	YTX24HL-BS *	-	Y50-N18L-A-CX

* See Battery Cross Reference Chart on page 17

† This battery includes a sensor

▪ Top and front terminal mounts only

1.2 AMP Automatic Battery Charger & Maintainer

Part No. YUA1P2AMPCH

- Automatically switches to maintenance mode when battery is fully charged
- Designed to prevent overcharging
- 5 year limited warranty



2 AMP Dual-bank Automatic Charger & Maintainer

Part No. YUA2AMPCH

- 2 independent charging stations
- Charges 6 & 12 volt batteries
- Automatic charging and maintenance maximizes battery life
- OEM-approved 5-stage charging algorithm saves time and energy
- Active desulfation to recover sulfated batteries
- Defective battery detection to eliminate surprises
- 5 year limited warranty



3 AMP Automatic Battery Charger & Maintainer

Part No. YUA3AMPCH

- Automatic charging and maintenance maximizes battery life
- OEM-approved 5-stage charging algorithm saves time and energy
- Active desulfation to recover sulfated batteries
- Defective battery detection to eliminate surprises
- 13 ft. total cable length including alligator clips
- 5 year limited warranty



Battery Charger Leads

Part No. YUA00ACC04 - 18AWG Wire, 3 amp fuse

Part No. YUA00ACC05 - 16AWG Wire, 15 amp fuse

- Compatible with all Yuasa consumer chargers and maintainers
- Support electrical accessories such as heated gear and GPS units



Jumper Cables

Part No. YUA00ACC07

- Convenient storage bag included
- Heavy duty, 8 ft., 8-gauge cables won't stiffen or freeze
- Tangle resistant, encased rubber grips for safer use



Digital Battery Print Tester



Part No. YUA00BTY01P

EASY, FAST, ACCURATE, AFFORDABLE

- Developed exclusively for powersports batteries
- Determines battery health and charge status in seconds
- Single load, dynamic resistance technology minimizes battery drain during test
- Tests both charged and discharged batteries accurately
- Digital battery tester prints recommended actions
- Charging system check
- 1 year limited warranty

12V

APPLICATION	12V Powersports Batteries 2.3 ~ 32AH
VOLTMETER	1.5V ~ 30V
THERMAL PRINTER	Prints results in seconds
INCLUDED ACCESSORIES	Heavy-duty Plastic Case 2 Rolls of Printer Paper 4 AA Batteries
LANGUAGES	English, French, Spanish, German, Italian, Portuguese
DIMENSION	195 (L) X 114 (W) X 50 (H) (mm)

TEST FLOW:

BATTERY TEST: ✓
12.88V

Application:
12V

BATTERY CATEGORY: ✓
AGM

Battery Category:
a. CONVENTIONAL
b. AGM

SET CAPACITY: ✓
20AH

GOOD & PASS: ✓
12.79V

4 Test Results:
a. Good & Pass
b. Good & Recharge
c. Recharge & Retest
d. Bad & Replace

PRINT RESULTS? ✓
YES

Replacement Paper Roll

Part No. YUABTY01PPR

- Thermal printing paper
- 2 rolls of printer paper



Small Display Rack

Part No. 60052

- 24" wide x 48" high x 10" deep
- Order header card separately



Small Battery Rack Header Card

Part No. YUA-SMHC



Large Display Rack

Part No. YUASARACK

- 37" wide x 62" high x 15" deep
- Order header card separately



Large Battery Rack Header Card

Part No. YUA-LGHC

Part No. YUA-LGHCM - Battery Applications



Metal Sign

Part No. YUA-888



Yuasa Smart Button

Part No. YUASMTBTN



Yuasa LED Sign

Part No. YUA-SIGN



3' x 5' Banner

Part No. YUA-001



Counter Stool

Part No. YUA-999



Any device that stores energy can be dangerous. There is a lot of explosive power in a gallon of gasoline, but when handled with some knowledge, its use can be made relatively safe. Batteries are no different in that with the proper precautions and safety practices, they can be

handled in a safe manner. Working with batteries poses two hazards: potentially explosive gases that are given off during discharging and charging, and sulfuric acid, which is highly corrosive. The safety chart below will help keep these two hazards under control:

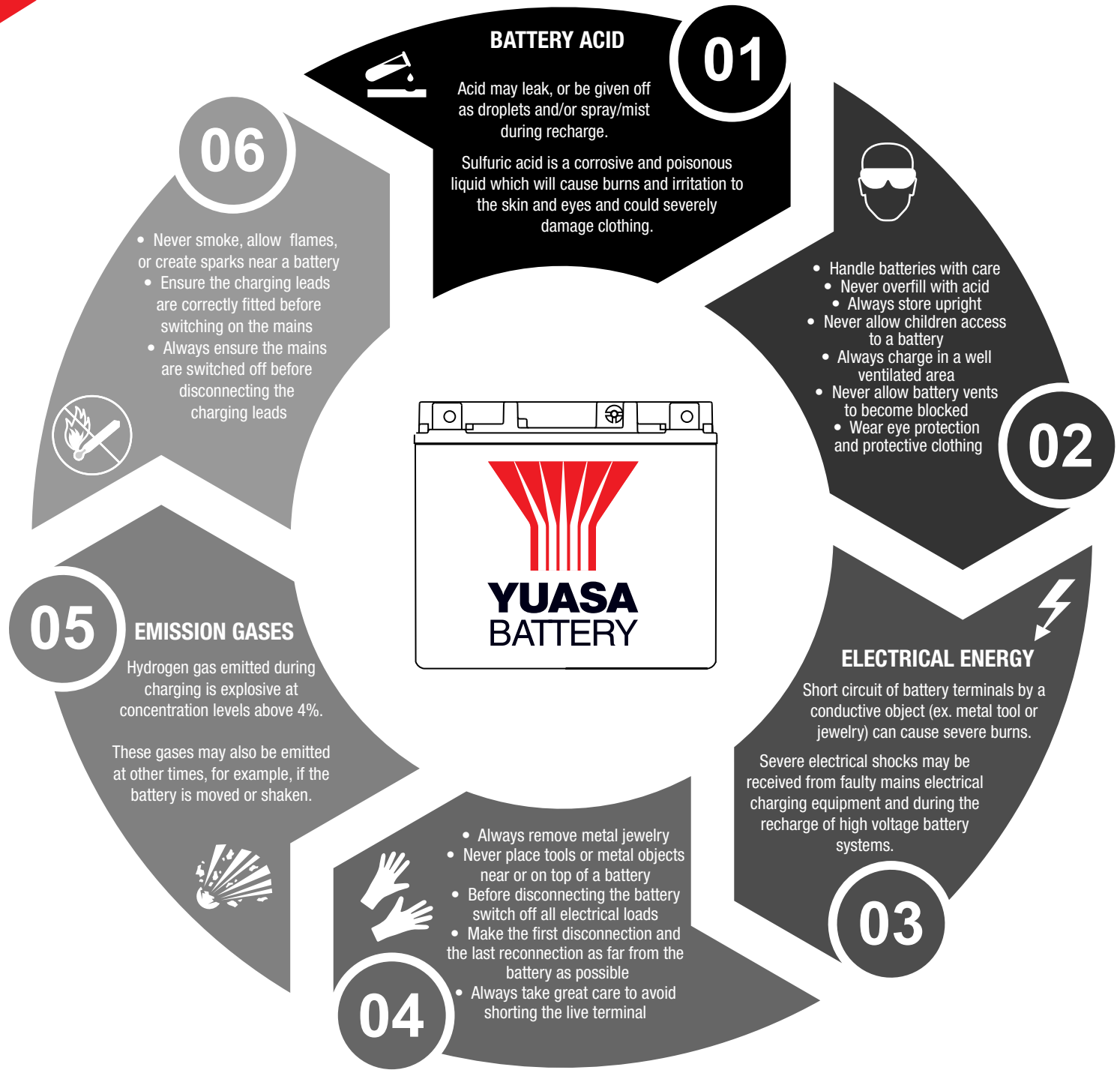

BATTERY CHARGING

Chemistry. During discharge, sulfuric acid is drawn from the electrolyte into the plates. This forms sulfate on the plates. Charging a battery reverses the chemical process that occurred during discharge, sending the sulfate back into the electrolyte as sulfuric acid. The electrical energy used to charge a battery is converted back to chemical energy and stored inside the battery. Battery chargers, including alternators and generators, produce a higher voltage (higher "electrical pressure") than the battery's open circuit voltage. For example, if a battery charger that outputs 14 volts is connected to a 12 volt battery, current flow will be from the charger into the battery. This high electrical pressure, or voltage, is required to push electrical current back into the battery, overcoming its open circuit voltage and thus providing charging current. The charging device (alternator, generator, or battery charger) produces excess electrons at the negative battery plates where positive hydrogen ions are then attracted to them. The hydrogen ions combine with the lead sulfate on the discharged plates to form sulfuric acid and lead, which ultimately reduces the amount of water in the electrolytic solution and increases the battery's specific gravity during the charging process.

HOW MANY AMPS?

Applying a charging current to a battery, without overheating

it, is called the "*natural absorption rate*". Because of their smaller size, when compared to automotive types of batteries, powersports batteries are more sensitive to how much current they can safely absorb. **When charging a motorcycle or other small battery, the battery charger should not exceed 3 amps.** Most automotive types of battery chargers are not suitable for charging a motorcycle battery because they output current above 3 amps. For the correct charge rate, a rule of thumb is to divide the battery's amp hour rating by 10. For example, a 14 AH battery should be charged at 1.4 amps ($14\text{AH} / 10 = 1.4$ amps).

When charging amperage exceeds the level of the natural absorption rate, the battery may overheat, causing the electrolyte solution to bubble, creating flammable hydrogen gas. Hydrogen gas, when combined with oxygen from the air, is highly explosive and can easily be ignited by a spark. Consequently, **always remember to turn the power off before connecting or disconnecting a battery charger to prevent a spark at the battery terminals!** Many battery chargers that are designed for use with small batteries have a "*no spark*" feature when being connected or disconnected from the battery. In addition to excessive out-gassing during charging, a battery that has been rapidly discharging (cranking an engine over until it's dead, for instance) may also produce excessive hydrogen gas.

Charging Times

State of Charge	Battery Types					
	YB14	YB30L	YTX14	YTX20HL	YIX30L	GYZ20L
Approximate Charge Times (Hours) Using a "Trickle" (0.25 Amp) Charger						
75%	18	38	15	23	38	25
50%	35	75	30	45	75	50
25%	53	113	45	68	113	75
0%	70	150	60	90	150	100
Approximate Charge Times (Hours) Using a 1 Amp Taper Charger						
75%	8	17	7	10	17	11
50%	14	30	13	18	30	20
25%	20	42	18	25	42	28
0%	27	56	23	33	56	37
Approximate Charge Times (Hours) Using a 1 Amp Constant Current Charger						
75%	4	9	4	6	9	6
50%	9	19	8	11	19	13
25%	13	28	11	17	28	19
0%	18	38	15	23	38	25

CHECKING A BATTERY

A routine should be established by which a battery is checked for state-of-charge and charged if necessary. Because access to the battery may be difficult on some vehicles, a permanent, quick connect/disconnect connector can be installed, allowing the battery charger to be connected to the vehicle's battery externally. When charging a battery, always refer to the instructions that come with the battery charger. While maintaining a battery at its full state-of-charge will insure optimum life, overcharging may significantly reduce the battery's life. Any of the Yuasa automatic chargers (1 AMP, 2 AMP and 3 AMP) will maintain both AGM and Conventional battery types without overcharging them. Use the following guidelines for charging AGM and Conventional batteries:

- Always verify battery state-of-charge before charging, and 30 minutes after charging.
- A battery charger has been disconnected from the battery for one to two hours, a fully charged Conventional battery should read 12.6 volts or higher.
- AGM batteries may have slightly higher voltage readings after a full charge.

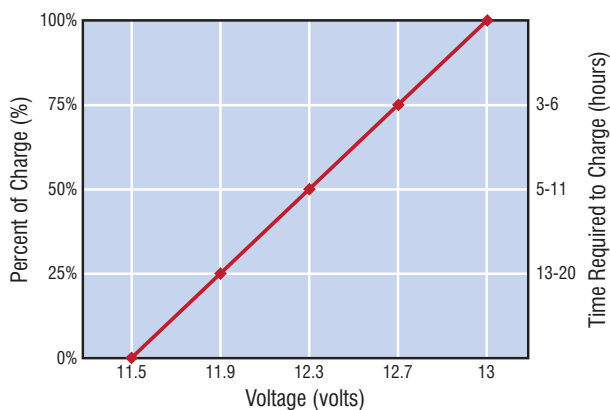

The approximate charging times are shown using a constant current charge (Yuasa charger) at the amps specified on the battery.

Do not overcharge. Because of the characteristics of an AGM battery, too much of a boost charge, or overcharging will decrease the volume of electrolyte. The longer the overcharge time, the greater the drop in electrolyte and starting power. The battery is sealed, water can not be added to make up the difference in the loss of electrolyte.

In addition, overcharging can warp cell plates making future charging difficult or impossible. To prevent overcharging, track charging times carefully, or ideally, use one of Yuasa's Automatic Chargers. Always stop charging if the battery case becomes too hot to touch. Let it cool down 6 to 12 hours and resume charging. Charging times will vary depending on charger type and battery size. **Caution:** *Always wear safety glasses when handling batteries and charge them in a well-ventilated area.*

CHARGING A DEEPLY DISCHARGED BATTERY

Batteries with an open circuit voltage below 11.5 volts may require a special charger and procedures to recharge. Deeply discharged batteries will have high internal resistance, making normal battery charging difficult. It may be necessary to use a charging voltage higher than normal to get the battery to accept a charge. The Yuasa Automatic 12V 4 AMP battery charger is capable of charging at a rate of 20 volts and has two current settings. Whether you use a Yuasa charger or another charger, charge the battery for 30 minutes and then measure the open circuit voltage. If the voltage reading has not increased (indicating that charging has taken place) the battery must be replaced. If the battery is accepting a charge, continue charging. During this process, if the battery's case temperature becomes too high (about 140° F) charging should be stopped or charging current should be reduced. The process of charging a deeply discharged battery may take up to 20 hours or more.

POINTS TO REMEMBER

- Prolonged discharge causes harmful sulfation and may damage a battery
- Discharged (dead) batteries are prone to freezing in cold temperatures
- Short trips may not provide enough battery charging time
- Always verify the state-of-charge 30 minutes after charging
- Storing batteries in high temperatures will cause damage to the battery
- Never exceed 3 amps when charging a motorcycle, or other small battery

HOW TO ACTIVATE AN AGM BATTERY

Yuasa AGM batteries leave the factory either FA or BS:

- **Factory Activated (FA)** – the battery is filled with electrolyte, sealed and charged at the factory. These batteries must be used within a period of time and cannot be stored indefinitely.
- **Bottle Supplied (BS)** – dry AGM batteries are shipped with the electrolyte stored in a plastic container. The battery is filled with electrolyte from the container when it's ready to be activated. AGM dry batteries have a shelf life of 5 years from the manufacturer, as long as they remain sealed. Proper seal for AGM batteries means a foil sealing strip in place on the battery without damage or flaw. Once a battery is unsealed it should be activated, charged, and installed. The plates of an unsealed battery will begin to oxidize, making it more difficult to charge later.

Activating an AGM battery (BS) is a simple process and differs from activating a Conventional battery. Non-activated AGM batteries can be stored for long periods of time as long as they are kept in a cool, dry location and out of direct sunlight. Also the foil sealing strip covering the filler ports should not be removed until the battery is ready to be activated. Use only the electrolyte container that comes with the battery for filling the cells as it has a higher concentration of sulfuric acid than the acid used for Conventional batteries.

It's also important to note that not all electrolyte containers are created equal. Typically, each contain has the proper amount of electrolyte for its specific battery. Always read the precautions and instructions on the electrolyte container before handling and filling your AGM battery.

Do not smoke when activating a battery or handling battery acid. Always wear plastic gloves and protective eye wear.



The electrolyte container that is shipped with a dry AGM battery contains the correct amount of battery acid and is more concentrated than the electrolyte used in a conventional battery.

THE 7-STEP PROCESS TO ACTIVATE AN AGM BATTERY:

1. The battery must be out of the vehicle and placed on a level surface.
2. Remove electrolyte container from the plastic storage bag. Remove the strip of caps and set it aside as it will be necessary later in the process. When filling your AGM battery use only the dedicated acid container that comes with the battery as it contains the proper amount of electrolyte for that specific battery. This is important to service life and battery performance. **Do not pierce, or otherwise open the foil seals on the electrolyte container. Do not attempt to separate the individual electrolyte containers.**

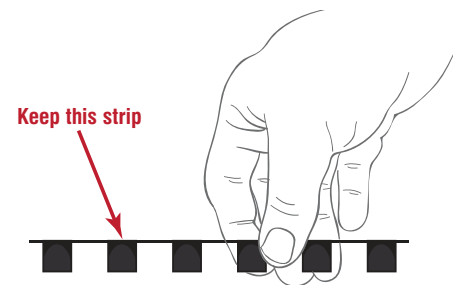

Do not puncture the foil seal or remove it prior to filling a dry AGM battery.

3. Place the electrolyte container with the foil seals facing down into the cell filler ports on the battery. Hold the container level and push down to break the foil seals. Electrolyte will start to flow into the battery and air bubbles will be seen inside the container. **Do not tilt the electrolyte container.**

4. Check the electrolyte flow. **Keep the container in place for 20 minutes or longer until it empties completely.** If no air bubbles are coming up from the filler ports, or if container cells haven't emptied completely after 20 minutes, tap the container gently and/or battery case a few times to cause the electrolyte to flow into the battery. Do not remove the acid container from the battery until it is completely empty. The battery requires the entire electrolyte from the container for proper operation.

Bubbles will appear as the electrolyte container fills the battery indicating the flow of battery acid. Tap the container periodically to keep the electrolyte flowing until the container is completely empty. **Never puncture the top of the acid container to speed up the filling process.**

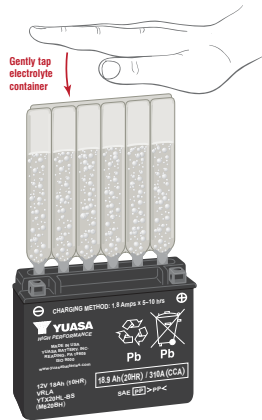

5. Carefully remove the empty electrolyte container from the battery. Fully insert the strip of sealing caps (previously removed from the electrolyte container) into the battery filling ports. Make sure the strip of caps is fully inserted and flush with the top of the battery. Insert the caps by hand, do not use a hammer or excessive force. **Never remove the strip of caps or add water or electrolyte to the battery during its service life.**



After filling, the sealing caps should be installed using hand pressure only. The sealing cap should never be removed once the battery is activated.

6. For batteries with ratings of less than 18 AH, let the battery stand for 20 to 60 minutes. For batteries with higher AH ratings, and/or having the **High Performance rating (designated by an "H" in the part number/name)** allow the battery to stand for 1 to 2 hours. Yuasa AGM batteries have the amp hour (AH) printed on the front of the battery case. The stand, or rest period, allows the electrolyte to permeate into the plates for optimum performance.

7. **Newly activated AGM batteries require an initial charge.** After adding electrolyte, a new battery is approximately 75-80% charged. After the "stand" period (step 6), charge the battery to bring it to a full state-of-charge. The battery charger used for initial charging should be able to charge at 12.8+ volts for an AGM battery. All Yuasa battery chargers are capable of reaching this minimum voltage and initializing/activating an AGM battery.

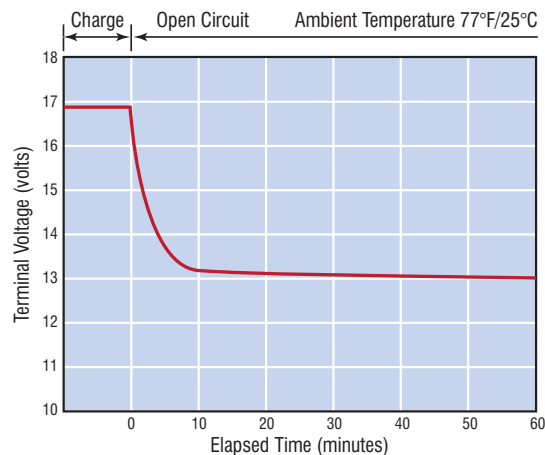

During the initial charging period, battery voltage may reach over 16 volts. Open circuit voltage should be checked after the battery is allowed to stand between 1 and 2 hours.

HOW TO ACTIVATE A CONVENTIONAL BATTERY

Sealed at the Yuasa factory, a new Conventional battery has shelf life of 2 years from manufacturer as long as it remains sealed (filler caps and red vent cap installed) and is stored at room temperature. Once the battery is unsealed, it should be activated and put into service. The cell plates on an unsealed, uncharged battery will oxidize making charging difficult and reducing the service life of the battery.

- The battery must be out of the vehicle and placed on a level surface. Remove filling caps (red, yellow or green colored battery caps).
- **Remove the red sealing cap from the vent elbow.** If the battery has a red cap on the vent elbow, remove it and throw it away. Never put this cap back on the battery after it is filled with acid as the buildup of internal gas pressure can cause the battery case to rupture.

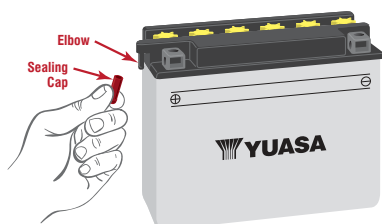

Always remove the red sealing cap from the vent elbow before filling and activating the battery.

- Using the acid bottle supplied with the battery, place the container upright on a flat surface. Carefully cut off the tip of the bottle's spout and attach the short tube provided. **Caution: Do not squeeze the bottle when cutting the fill tip. Do not smoke when activating a battery or handling battery acid. Always wear plastic gloves and protective eye wear.**
- Fill the battery with electrolyte supplied with the battery. Do not use water or any other liquid to activate a battery. Electrolyte should be between 60° F and 86° F before filling. If electrolyte is stored in a cold area, it should be warmed to room temperature before filling. Fill to the UPPER LEVEL as indicated on the battery. *NOTE: Never fill/activate a battery installed in a vehicle as electrolyte spillage can cause damage.*

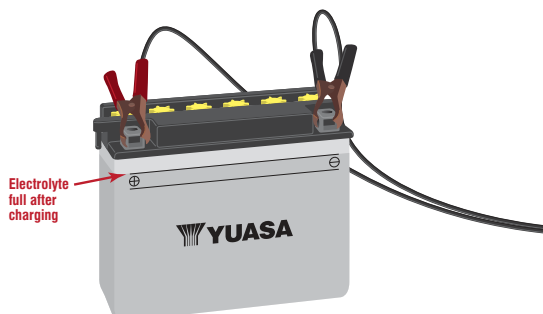

Make sure that the acid level is to the upper mark after the battery is initially charged. If the level is low fill with electrolyte.

- Fill each battery cell slowly and carefully to the highest level line.
- Let the battery stand for at least 30 minutes after filling. Move or gently tap the battery so that any air bubbles between the plates will be expelled. If the acid level has fallen, refill with acid to upper level.

Post-Fill Stand Time

Amp-Hour

<18
>18
High Performance

Stand Time

30-60 minutes
1-2 hours
1-2 hours

- Filling a Conventional battery with electrolyte will bring it to 75-80% of a full charge. **A battery must be charged to 100% before putting it into service.** To find recommended charging current requirements in amps for a specific battery, divide battery ampere-hour capacity rating by 10. For example a 14 AH battery should be charged at 1.4 amps ($14 \text{ AH} \div 10 = 1.4 \text{ amps}$). The specific gravity of the electrolyte should rise to at least 1.260 on 12N series batteries. On all High Performance batteries (YB Series) a minimal reading of 1.280 should be observed.
- During initial charging, check to see if the electrolyte level has fallen, and if so, fill with acid to the UPPER LEVEL. After adding acid, charge for another hour at same rate as above to mix the water and acid together. Note: This is the last time electrolyte should be added to the battery. If the level is low during use, distilled water should be added as required.
- When charging is complete, replace filler cap plugs and tighten by hand—**do not use a screwdriver or pliers.** Wash off spilled acid with a water and baking soda solution, paying particular attention that any acid is washed off the terminals. Dry the battery case and install the battery.

BATTERY INSTALLATION

In most applications, batteries should be installed in an upright position. If there is any question regarding a particular vehicle/battery/installation please contact us for our specific recommendations before installation. www.yuasabattery.com

AGM batteries that come with separate acid packs that are used to fill and activate the battery should not be installed in any position other than upright, as possible electrolyte leakage may occur. Also, **Conventional and Yumicron batteries should never be installed in any position other than upright as their liquid electrolyte will leak from the battery case causing damage to the vehicle.**

Disclaimer: *Yuasa batteries are to be mounted in a position identical to the position in which they were mounted in the vehicle by the manufacturer. Any position other than the "0°" position (upright) requires a "non-spillable" "Factory Activated" battery.*

Yuasa Battery assumes no responsibility for damages and/or injuries incurred due to a battery being mounted in a position other than what was originally used in the vehicle by the manufacturer. All "-BS" and Conventional "Flooded" batteries are to be mounted in the "0°" (upright) normal/center position.



INSPECTING A BATTERY

Battery testing should begin with an inspection of the battery using the following steps:

- **Make sure the top of the battery case is clean and dry.** If the case of a battery is dirty it can cause the battery to discharge through the grime on top of the case. Use a soft brush and water and soap or a solution of baking soda and water to clean the battery case or terminals. On a Conventional battery, make sure filler

cap plugs are finger tight so cleaning materials will not enter the cells and neutralize the acid.

- **Inspect battery terminals, screws, clamps and cables for problems including: breakage, corrosion or loose connections.** Clean the terminals and clamps with a wire brush. Once battery cables are installed, dielectric grease (available at most auto parts stores) or clear lacquer from a spray can applied to the terminals will help prevent oxygen from causing corrosion on the battery terminals.
- **Inspect the battery case for obvious damage such as cracks or leaks;** look for discoloration, warping or raised battery case top, which may indicate that battery has overheated or been overcharged.
- **For Conventional batteries, check electrolyte level and add distilled water if necessary. Don't add acid—only distilled water.** Before any testing, charge the battery so the water and acid mix.

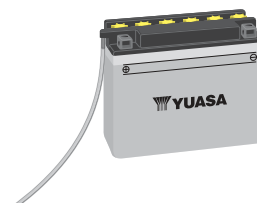

- **If equipped, check the battery vent tube. Make sure it's not kinked, pinched or otherwise obstructed.** On a motorcycle, it should exit away from the drive chain and from below the swing arm. Small cuts in the tube near the battery vent are OK; they form an emergency escape for trapped gas in case the vent tube becomes obstructed.

BATTERY TESTING – HYDROMETER

Conventional batteries have filler caps which their state-of-charge can be checked using a hydrometer by measuring specific gravity. If, after charging, the battery's specific gravity does not increase to indicate a full charge, the battery should be replaced.

A hydrometer measures the ratio of sulfuric acid to water, or the specific gravity of the electrolyte. The specific gravity for pure water is 1.000 and sulfuric acid has an specific gravity of 1.835. Combined, their specific gravity is controlled at 1.280.

Yumicron batteries use sulfate stop, a chemical additive that increases battery life by reducing sulfate buildup. Sulfate stop may cause a slight increase in specific gravity readings for these types of batteries. **A battery's specific gravity changes with temperature.** Ideally, readings should be taken at 77° F. If the temperature is much colder or hotter, a conversion factor can be used to obtain an accurate reading. Add .001 to the specific gravity for every 3° F above 77° F and subtract .001 from the specific gravity for every degree below 77° F. Specific gravity has a direct relationship to battery cell voltage. By adding .84 to the specific gravity number, the cell voltage can be calculated. For example, an specific gravity of 1.280 + .84 = 2.12 volts. Multiply 2.12 volts x 6 (six cells for a 12 volt battery) and the result is 12.72 volts—indicating a fully charged battery.

BATTERY TESTING – DIGITAL BATTERY PRINT TESTER



Yuasa's digital battery print tester uses single load dynamic resistance technology to calculate battery performance. The test provides information on open circuit voltage, state-of-charge, both charged and discharged batteries and system check. Before testing be sure to:

- Make sure the area around battery is well ventilated while battery is being tested.
- Clean battery terminals. Be careful to keep corrosion from coming in contact with eyes.
- Inspect the battery for cracked or broken case or cover
- If battery is damaged, do not use tester.

- If the battery is not sealed maintenance free, add distilled water in each cell until battery acid reaches level specified by the manufacturer. This helps purge excessive gas from cells. Do not overfill.
- If necessary to remove battery from vehicle to test, always remove ground terminal from battery first. Make sure all accessories in the vehicle are off to ensure you do not cause any arcing.

DIGITAL BATTERY TESTER INSTRUCTIONS

- When testing a battery in a powersports vehicle, turn off the vehicle and all accessory loads. The battery will hold surface charge if the engine has been running for a while or after the battery has just been charged. For a battery in a powersports vehicle, please turn on the headlights for 30 seconds to remove the surface charge.
- Make sure the battery terminals are clean. Wire brush them if necessary. Clamp the black load lead to the vehicle negative battery terminal. Clamp the red load lead to the vehicle positive battery terminal.
- Make sure you insert 4 AA batteries into the battery chamber located on the back of the tester. Oxyride batteries are not recommended because of the initial 1.7 volt output. If the 1.5 volt battery runs out of power, screen will show “REPLACE INTERNAL BATTERY” or “POWER LOW”. Replace those 4 AA batteries before starting the test.
- You will see the battery voltage measured as connecting to battery. Press «ENTER» key

BATTERY VOLT
XX.XXV

- Press ◀▶ key to select the battery type:

- STAND
- VRLA/MF/AGM/SLA
- Press «ENTER» to confirm choice

BATTERY TYPE
STANDARD SLI

- Press ◀▶ key to input the battery capacity of AH: 2~35 Press «ENTER» to begin the test
- Press the ◀▶ key to select battery charged: Yes or No Press «ENTER» to confirm choice

When test is completed, the display shows the actual volts, SOH (state of health) or SOC (state of charge). One of six results will be displayed:

GOOD & PASS

The battery is good & capable of holding a charge.

GOOD & PASS
XX.XXV

GOOD & RECHARGE

The battery is good but needs to be recharged.

GOOD & RECHARGE
XX.XXV

RECHARGE & RETEST

Battery is discharged. The battery condition cannot be determined until it is fully charged. Recharge & retest the battery.

RECHARGE & RETEST
XX.XXV

BAD & REPLACE

The battery will not hold a charge. It should be replaced immediately.

BAD & REPLACE
XX.XXV

BAD CELL & REPLACE

The battery has at least one cell short circuit. It should be replaced immediately.

BAD CELL & REPLACE
XX.XXV

PAPER LOAD



Part No. YUABTY01PPR

LOAD ERROR

The tested battery is bigger than 200 AH, or the clamps are not connected properly. Please fully charge the battery and retest after excluding both previous reasons. If reading is the same, the battery should be replaced immediately.

LOAD ERROR

PAPER LOAD STEPS

Open the clear cover. Insert paper to the paper feeding for running the paper into printer automatically.

STEP 1

Clamp to the battery

STEP 2

Open the clear cover

STEP 3

Feed the paper into the paper slot until it runs automatically

SYSTEM CHECK

- Press «ENTER» key, you will view the screen

SYSTEM TEST
XX.XXV

- Turn off all powersports vehicle accessories such as lights, radio, etc. before starting the engine

TURN OFF ACC.
START ENGINE

- When the engine is started, one of the three results will be displayed along with the actual reading measured:

CRANKING VOLTS NORMAL

The system is showing normal draw.

Press «ENTER» to perform the charging system test.

CRANKING VOLTS
XX.XXV NORMAL

CRANKING VOLTS LOW

The cranking voltage is below normal limits, troubleshoot the starter with manufacturers recommended procedure.

CRANKING VOLTS
XX.XXV LOW

CRANKING VOLTS NOT DETECTED

The cranking voltage is not detected.

CRANKING VOLTS
NOT DETECTED

- If the cranking voltage is normal, press «ENTER» to begin charging system test
- Press the «ENTER» button, you will view the screen

PRESS ENTER FOR
= CHARGING TEST =

MAKE SURE ALL
ACC. ARE OFF

- Press «ENTER» key, one of the three results will be displayed along with the actual reading measured.

LOW CHARGING VOLTS WHEN TEST AT IDLE

The alternator is not providing sufficient current to the battery. Check the connections from the alternator to the battery. If the connection is loose or heavily corroded, clean or replace the cable and retest. Contact qualified technician if condition remains the same.

ALT. IDLE VOLTS
XX.XXV LOW

CHARGING SYSTEM NORMAL WHEN TEST AT IDLE

The system is showing normal output from the alternator. No problem is detected.

ALT. IDLE VOLTS
XX.XXV NORMAL

HIGH CHARGING VOLTS WHEN TEST AT IDLE

The voltage output from the alternator to the battery exceeds the normal limits of a functioning regulator. Check to ensure there is no loose connection and the ground connection is normal. If there is no connection issue contact a qualified technician.

ALT. IDLE VOLTS
XX.XXV HIGH

CHARGING SYSTEM HIGH WHEN TESTED WITH ACC.

The voltage output to the battery exceeds the normal limit of a functioning regulator. Check to make sure there are no loose connections and the ground connection is correct. If there are no connection issues, replace the regulator; since most regulators are now built into the alternator this will require the alternator to be replaced.

ALT. LOADS VOLTS
XX.XXV HIGH

- Following the charging system at idle, press «ENTER» for the charging system with accessory loads. Turn on high beam headlights.

TURN ON LOADS
AND PRESS ENTER

CHARGING SYSTEM LOW WHEN TESTED WITH ACC.

The alternator is not providing sufficient current for the system's electrical loads and the charging current for the battery. Check the connections from the alternator to the battery, if the connections are loose or heavily corroded clean and replace the cable and retest. If the condition still exists see a qualified technician.

ALT. LOADS VOLTS
XX.XXV LOW

EXCESS RIPPLE DETECTED

One or more diodes in the alternator are not functioning or there is stator damage. Have the alternator tested and repaired or replaced.

RIPPLE DETECTED
XX.XXV HIGH

BATTERY MAINTENANCE

AGM BATTERIES do not have to be checked as often as Conventional batteries—about every three months, or three months from the date of battery activation at the factory if stored at room temperature. Higher storage temperatures cause faster self-discharge and requires that batteries be checked more often. The battery will last longer if it is 100% charged most of the time and any of the Yuasa automatic chargers will maintain a battery for optimum performance and long service life. AGM batteries have a predetermined quantity of electrolyte added at the factory or in the field specified for the battery. Once activated, the battery is permanently sealed and must never be opened. The addition of water is never required for an AGM battery. **The single most important aspect to maintaining an AGM battery is to not let it sit discharged for long periods of time—keep it fully charged for peak performance.**

CONVENTIONAL BATTERIES should be checked for state-of-charge about once per month if not used on a regular basis. Recharging may be required if the vehicle is not used for more than two weeks or if the starter turns slower than usual when starting the engine. A Conventional battery requires the periodic addition of distilled water when the electrolyte level becomes low. Water loss is normal in these batteries through the process of electrolysis and evaporation. Low electrolyte levels that expose the lead plates to the air will result in

permanent damage to the battery. Maintain the electrolyte levels above the minimum fill lines on the battery and at or below the maximum line. Clean terminals and connectors as necessary and make sure the vent tube is free of kinks or clogs. Always replace filler caps and finger-tighten only.

BATTERY STORAGE

If the vehicle is in storage or used infrequently, disconnect the battery cable to eliminate current drain from electrical equipment. Check the battery every month (for Conventional types) and every three months for AGM batteries. If open circuit voltage indicates a low state-of-charge, charge the battery. **Temperatures below 60° F or above 80° F may require more frequent inspections and/or charging.**

SULFATION AND FREEZING

The two most common reasons that batteries can become damaged are sulfation and freezing. These are not a problem if the battery is properly charged, and for Conventional batteries the water level is maintained. Battery sulfation takes place for two reasons: continuous discharging, or low electrolyte levels. When a battery discharges, the lead in the plates turn into lead sulfate. The lead sulfate is actually a crystal which grows larger when the discharge is continuous and uninterrupted. In a Conventional battery, low electrolyte levels expose the cell plates to air causing the lead material to oxidize and form sulfates.

In either case it doesn't take long before the battery won't hold a charge. Low electrolyte levels cause another problem because the acid in the electrolyte becomes more concentrated, causing the active material to corrode and fall to the bottom of the battery case. If this condition takes place over a long enough time period, the process will internally short out the battery.

Electrolyte Freezing Points

Specific Gravity of Electrolyte	Freezing Point
---------------------------------	----------------

1.265	-75°F
1.225	-35°F
1.200	-17°F
1.150	+5°F
1.100	+18°F
1.050	+27°F

A battery that is fully charged can be stored at low temperatures without freezing. This chart shows that as specific gravity (state-of-charge) decreases, the battery will freeze at a higher temperature.

For added protection, Yuasa's Yumicron and AGM batteries are treated with a special chemical formula called "Sulfate Stop." This dramatically reduces sulfate crystal buildup on cell plates resulting in longer battery life. For example, Yuasa conducted a test on two batteries; one with sulfate stop, and the other without. Both batteries were under the constant discharge of a 10-watt bulb for a week. The battery with sulfate stop was charged with a 90% recover rate. The untreated battery could not be charged enough to put it back into service.

Freezing is not a problem with a fully charged battery. However if the battery becomes discharged (and the acid in the electrolyte turns into mostly water) the electrolyte will freeze. Freezing can cause a condition called "mossing" which is indicated by small red lines on the battery plates. Freezing can also crack the battery case and buckle the plates permanently damaging the battery. A fully charged battery can be stored at subfreezing temperatures with no damage. As the chart on this page indicates, a fully charged battery will not freeze unless the temperature drops below -75° F. By contrast a discharged (dead) battery will freeze at only 27° F. That's a difference of more than 100 degrees between the low temperatures a charged and discharged battery can withstand.

A series of horizontal lines for writing, with green circles on the left side indicating binding points.

YUASA  **BATTERY**

ADVANCED ENGINEERING

UNMATCHED RELIABILITY

PREMIUM QUALITY

EACH AND EVERYDAY...

It *starts* with us

2901 Montrose Avenue
Laureldale, PA 19605
866.431.4784

customerservice@yuasainc.com

www.yuasabatteries.com

